

FED. ROAD DIST. NO.	STATE	PROJ. NO.	FISCAL YEAR	SHEET NO.	TOTAL SHEETS
HAWAII	HAW.	450B-01-94M	1994	19	31

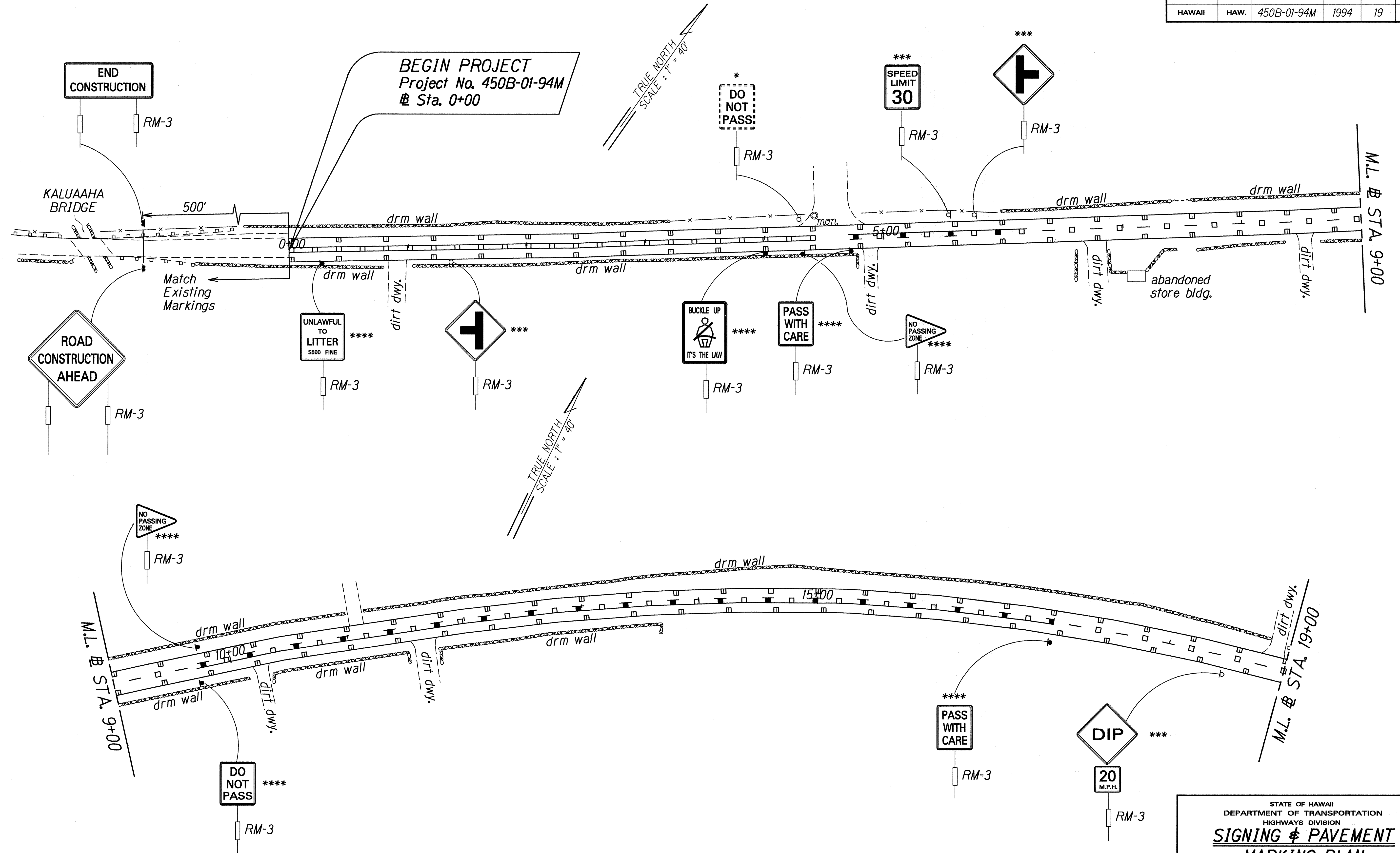

SURVEY PLOTTED BY _____ DATE _____
 DRAWN BY _____
 DESIGNED BY _____
 QUANTITIES BY _____
 CHECKED BY _____
 ORIGINAL PLAN _____
 NOTE BOOK _____
 7/10/94
 &ms/mpl/dgn

STATE OF HAWAII
 DEPARTMENT OF TRANSPORTATION
 HIGHWAYS DIVISION
SIGNING & PAVEMENT
MARKING PLAN
 KAMEHAMEHA V HIGHWAY RESURFACING
 Kilohana School to Waialua
 Project No. 450B-01-94M
 Scale: 1" = 40' Date: May, 1994
 SHEET No. 1 OF 12 SHEETS

FED. ROAD DIST. NO.	STATE	PROJ. NO.	FISCAL YEAR	SHEET NO.	TOTAL SHEETS
HAWAII	HAW.	450B-01-94M	1994	20	31

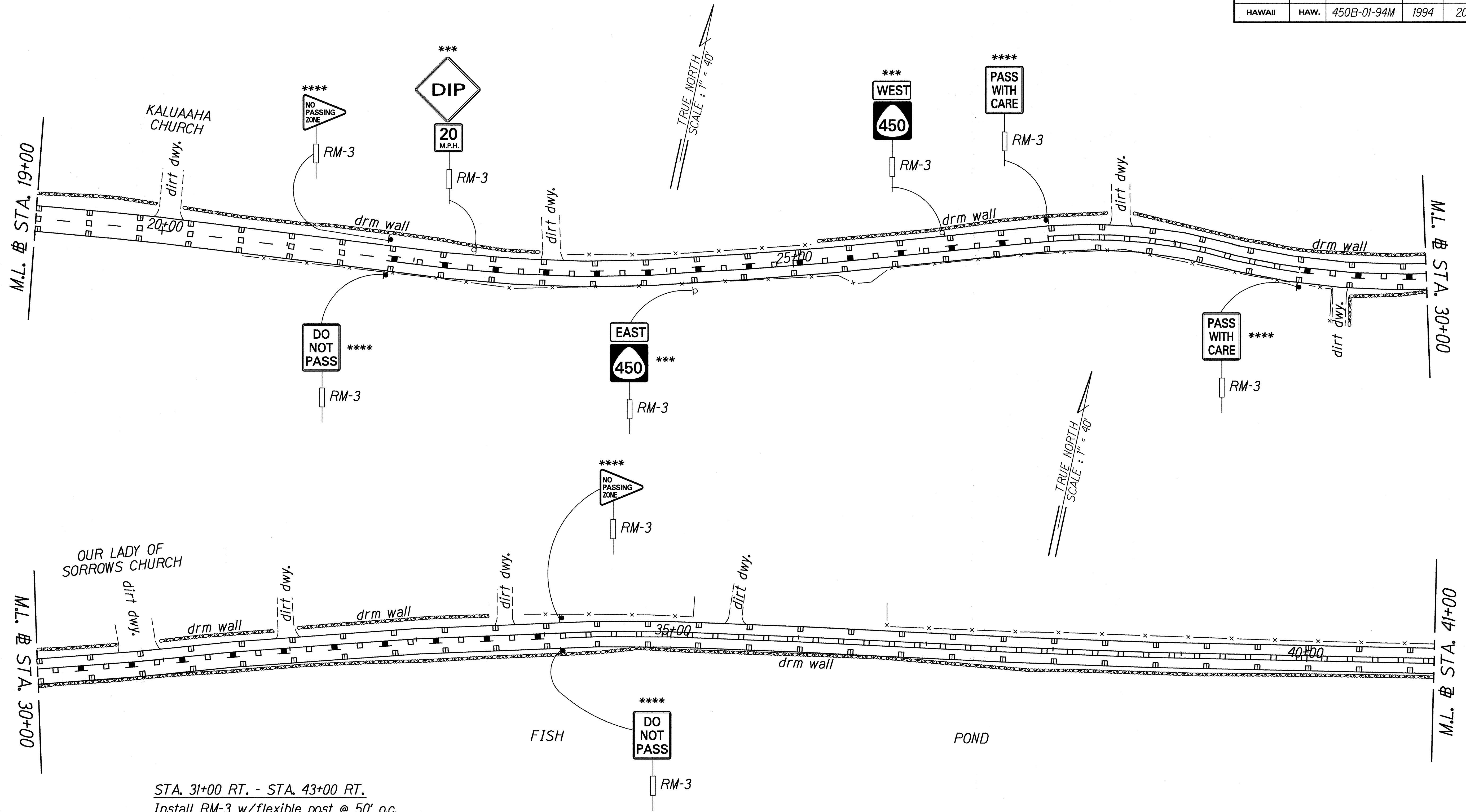

STA. 31+00 RT. - STA. 43+00 RT.
 Install RM-3 w/flexible post @ 50' o.c.

DATE	APRIL 1994
DESIGNED BY	J. L. GUERLON
CHECKED BY	C. HANSEN
QUANTITIES BY	
DESIGNED BY	
CHECKED BY	
QUANTITIES BY	
DESIGNED BY	
CHECKED BY	
QUANTITIES BY	

STATE OF HAWAII
 DEPARTMENT OF TRANSPORTATION
 HIGHWAYS DIVISION
SIGNING & PAVEMENT
MARKING PLAN
 KAMEHAMEHA V HIGHWAY RESURFACING
 Kilohana School to Waialua
 Project No. 450B-01-94M
 Scale: 1" = 40' Date: May, 1994
 SHEET No. 2 OF 12 SHEETS

FED. ROAD DIST. NO.	STATE	PROJ. NO.	FISCAL YEAR	SHEET NO.	TOTAL SHEETS
HAWAII	HAW.	450B-01-94M	1994	21	31

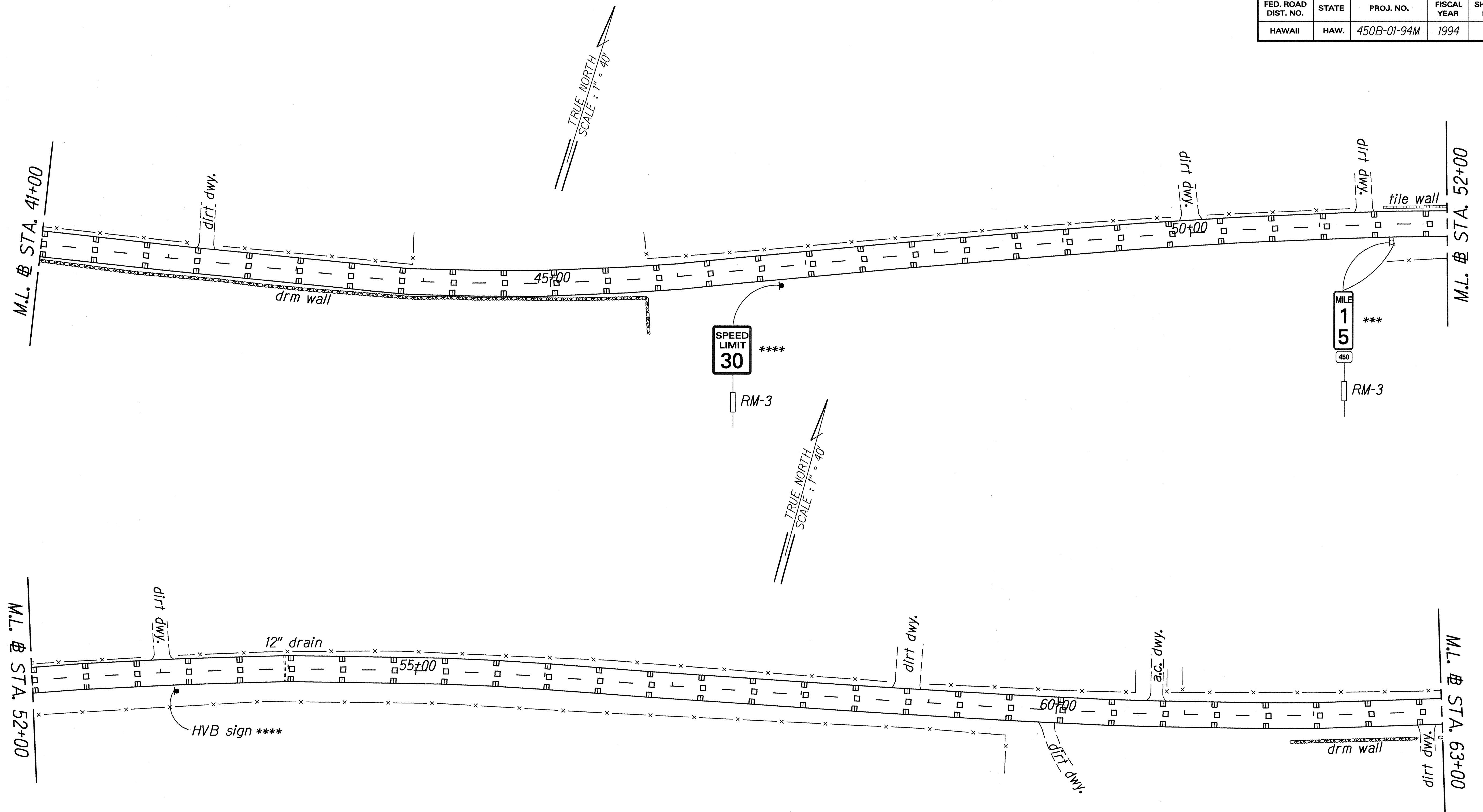

ORIGINAL PLAN	DATE
DRAWN BY J. G. G. G.	April 1994
TRACED BY	
DESIGNED BY C. F. H. H.	
QUANTITIES BY	
CHECKED BY	

STATE OF HAWAII
DEPARTMENT OF TRANSPORTATION
HIGHWAYS DIVISION
SIGNING & PAVEMENT
MARKING PLAN
KAMEHAMEHA V HIGHWAY RESURFACING
Kilohana School to Waialua
Project No. 450B-01-94M
Scale: 1" = 40' Date: May, 1994
SHEET No. 3 OF 12 SHEETS

FED. ROAD DIST. NO.	STATE	PROJ. NO.	FISCAL YEAR	SHEET NO.	TOTAL SHEETS
HAWAII	HAW.	450B-01-94M	1994	22	31

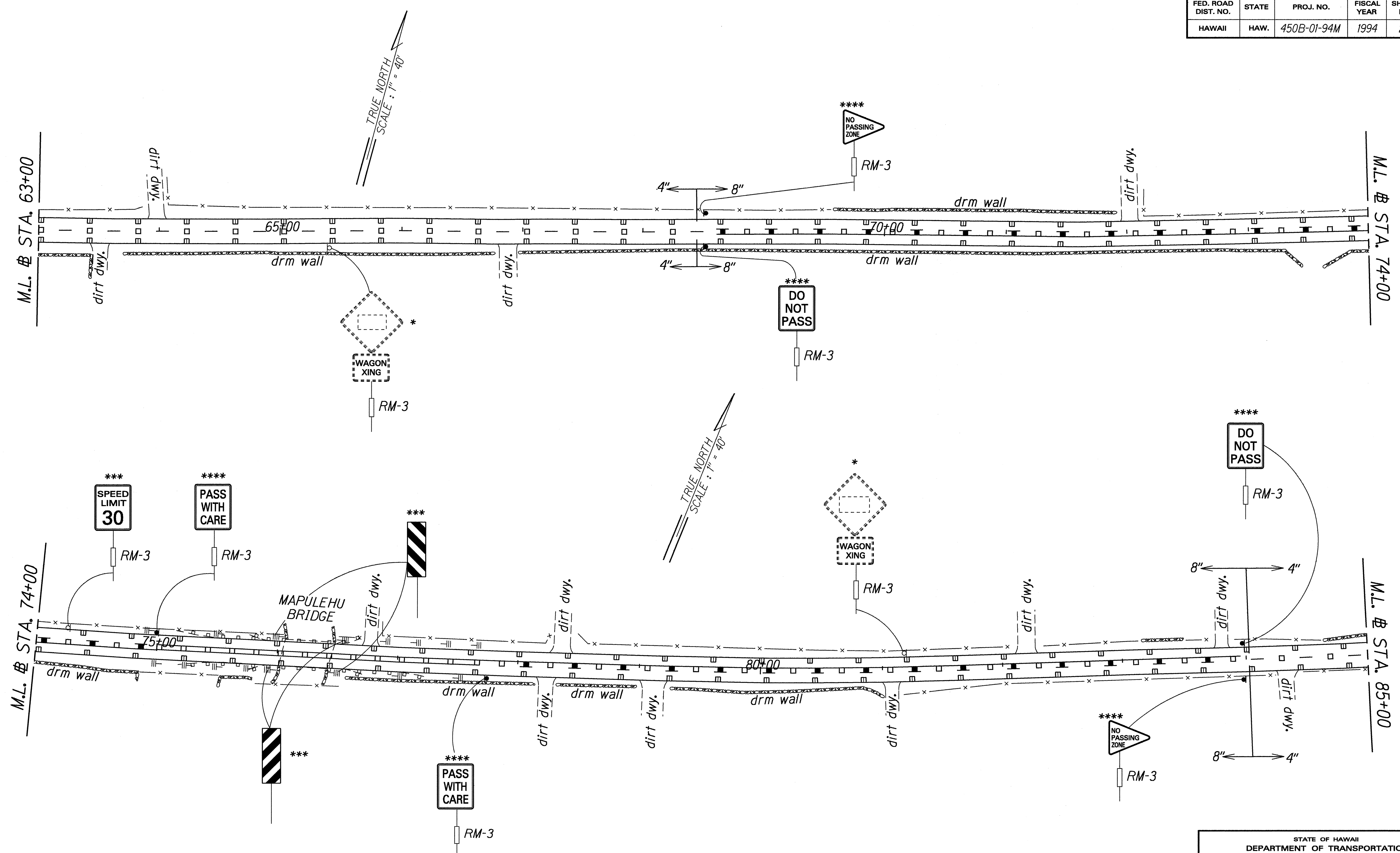

DATE	APRIL 1994
DESIGNED BY	C. HARRIS
CHECKED BY	2/25/94/1/1/94
DESIGNED BY	
CHECKED BY	
DATE	
DESIGNED BY	
CHECKED BY	

STATE OF HAWAII
DEPARTMENT OF TRANSPORTATION
HIGHWAYS DIVISION
SIGNING & PAVEMENT
MARKING PLAN
KAMEHAMEHA V HIGHWAY RESURFACING
Kilohana School to Waialua
Project No. 450B-01-94M
Scale: 1" = 40' Date: May, 1994
SHEET No. 4 OF 12 SHEETS

FED. ROAD DIST. NO.	STATE	PROJ. NO.	FISCAL YEAR	SHEET NO.	TOTAL SHEETS
HAWAII	HAW.	450B-01-94M	1994	23	31

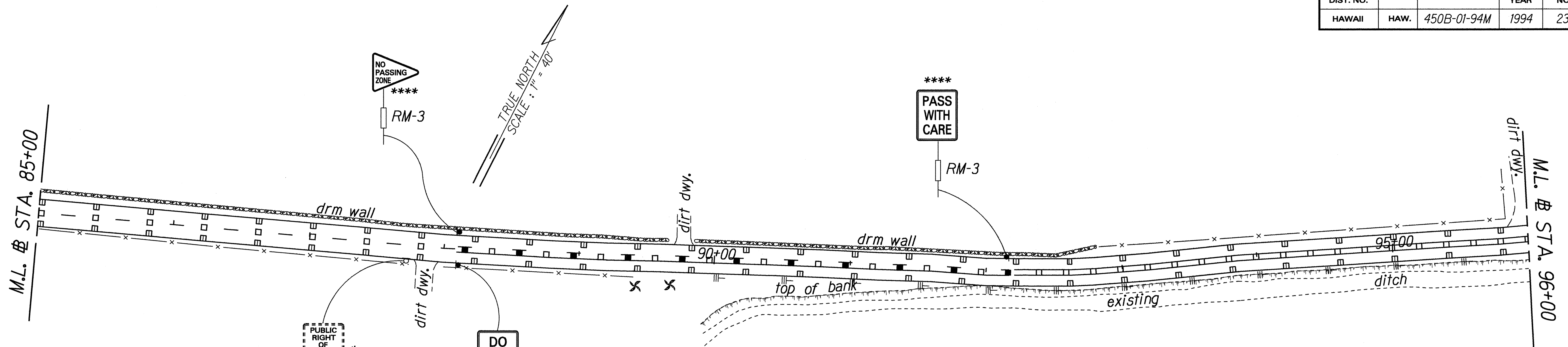

STA. 90+00 RT. - STA. 102+50 RT.
Install RM-3 w/flexible post @ 50' o.c.

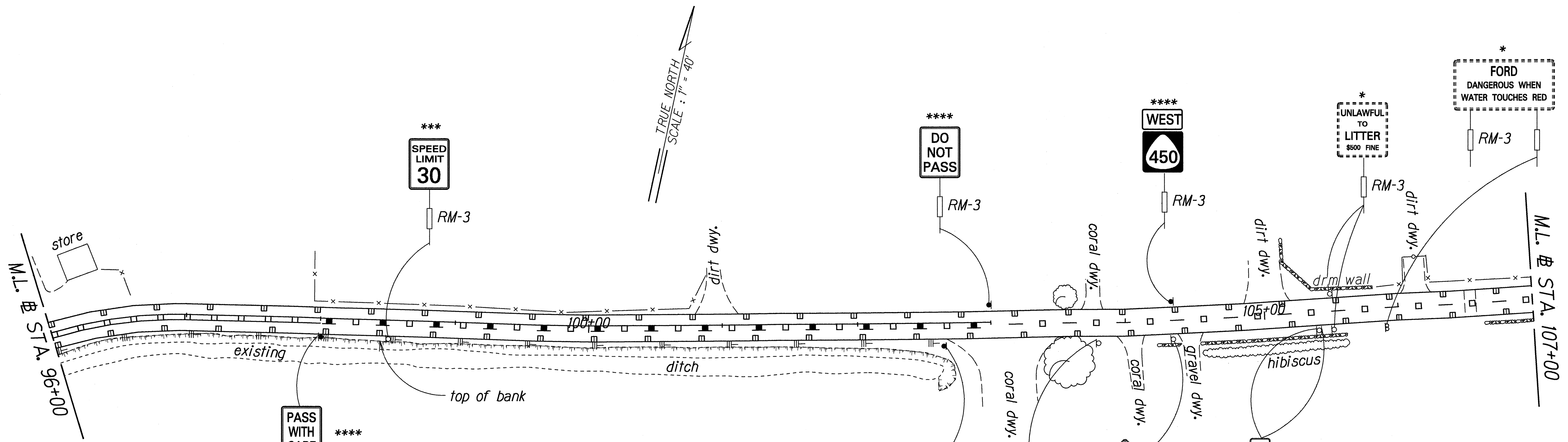

ORIGINAL PLAN	DATE
SURVEY PLOTTED BY	April 1994
DRAWN BY	J. L. Guerrero
DESIGNED BY	C. Burgess
QUANTITIES BY	
CHECKED BY	

STATE OF HAWAII
DEPARTMENT OF TRANSPORTATION
HIGHWAYS DIVISION

SIGNING & PAVEMENT MARKING PLAN

KAMEHAMEHA V HIGHWAY RESURFACING
Kilohana School to Waialua
Project No. 450B-01-94M
Scale: 1" = 40' Date: May, 1994

FED. ROAD DIST. NO.	STATE	PROJ. NO.	FISCAL YEAR	SHEET NO.	TOTAL SHEETS
HAWAII	HAW.	450B-01-94M	1994	24	31

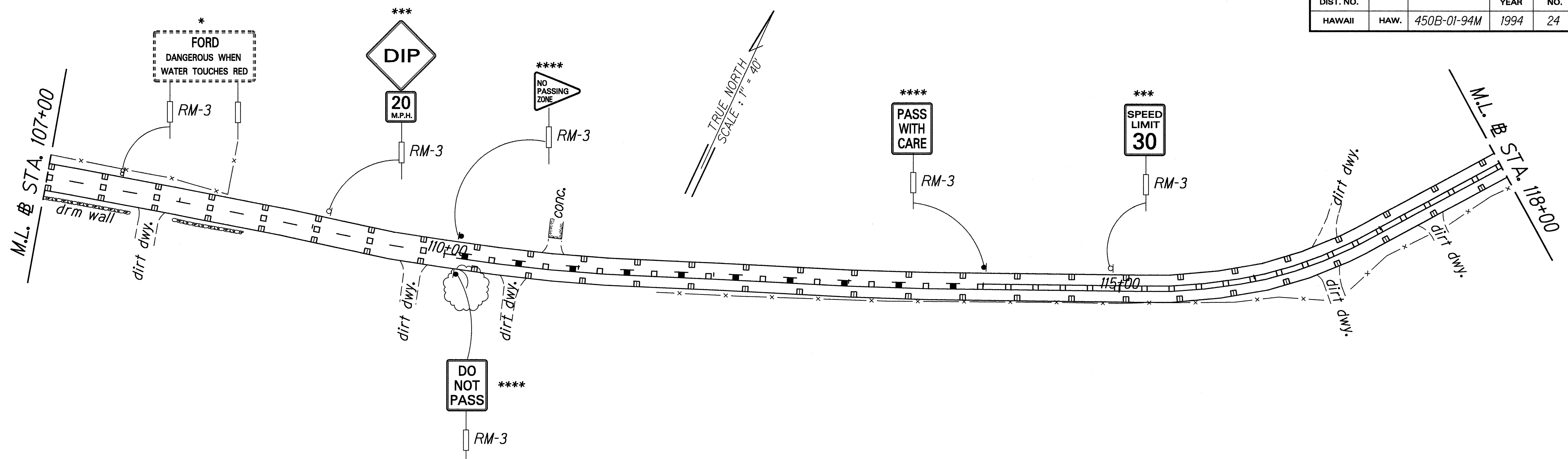

STA. 120+00 LT. - STA. 123+00 LT.
Install RM-2 @ 50' o.c. (bi-directional)

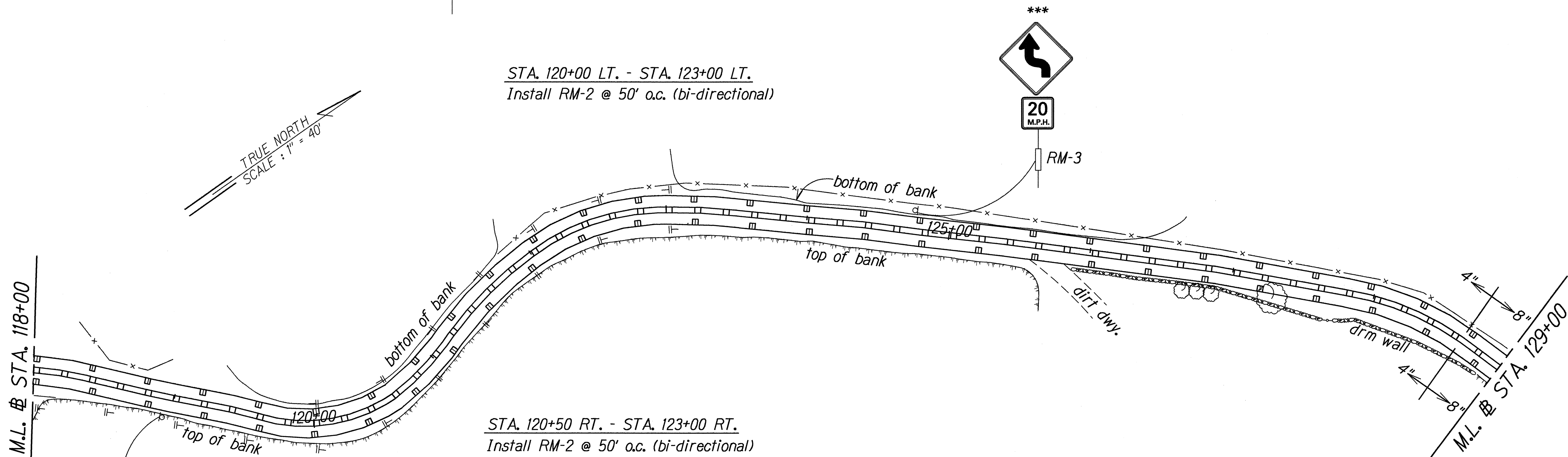

STA. 120+50 RT. - STA. 123+00 RT.
Install RM-2 @ 50' o.c. (bi-directional)

STA. 118+00 RT. - STA. 120+00 RT.
Install RM-3 w/flexible post @ 50' o.c.

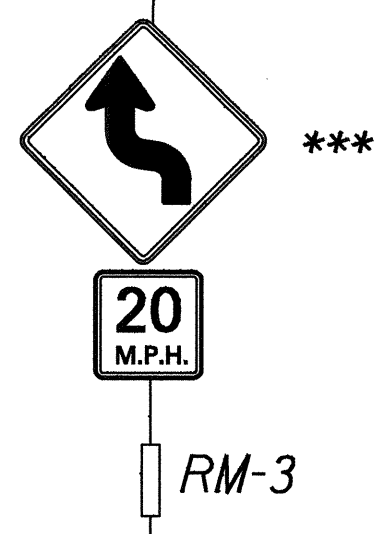

ORIGINAL PLAN	DATE
DESIGNED BY	APRIL 1994
CHECKED BY	
QUANTITIES BY	
REVISIONS	

STATE OF HAWAII
DEPARTMENT OF TRANSPORTATION
HIGHWAYS DIVISION
SIGNING & PAVEMENT
MARKING PLAN
KAMEHAMEHA V HIGHWAY RESURFACING
Kilohana School to Waialua
Project No. 450B-01-94M
Scale: 1" = 40' Date: May, 1994
SHEET No. 6 OF 12 SHEETS

FED. ROAD DIST. NO.	STATE	PROJ. NO.	FISCAL YEAR	SHEET NO.	TOTAL SHEETS
HAWAII	HAW.	450B-01-94M	1994	25	31

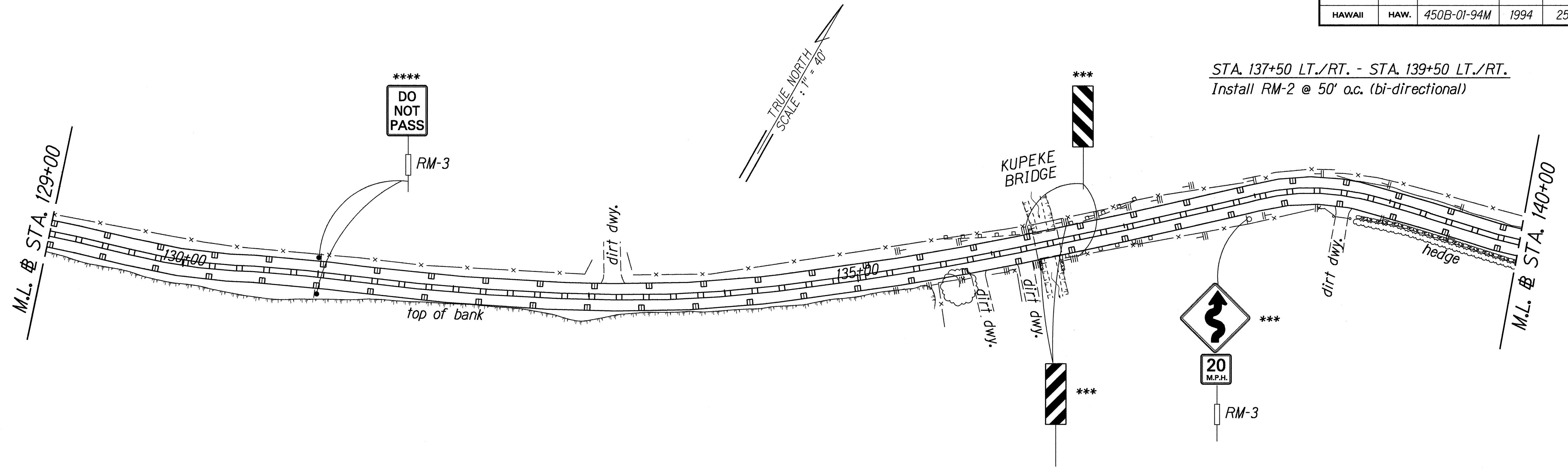

STA. 137+50 LT./RT. - STA. 139+50 LT./RT.
Install RM-2 @ 50' o.c. (bi-directional)

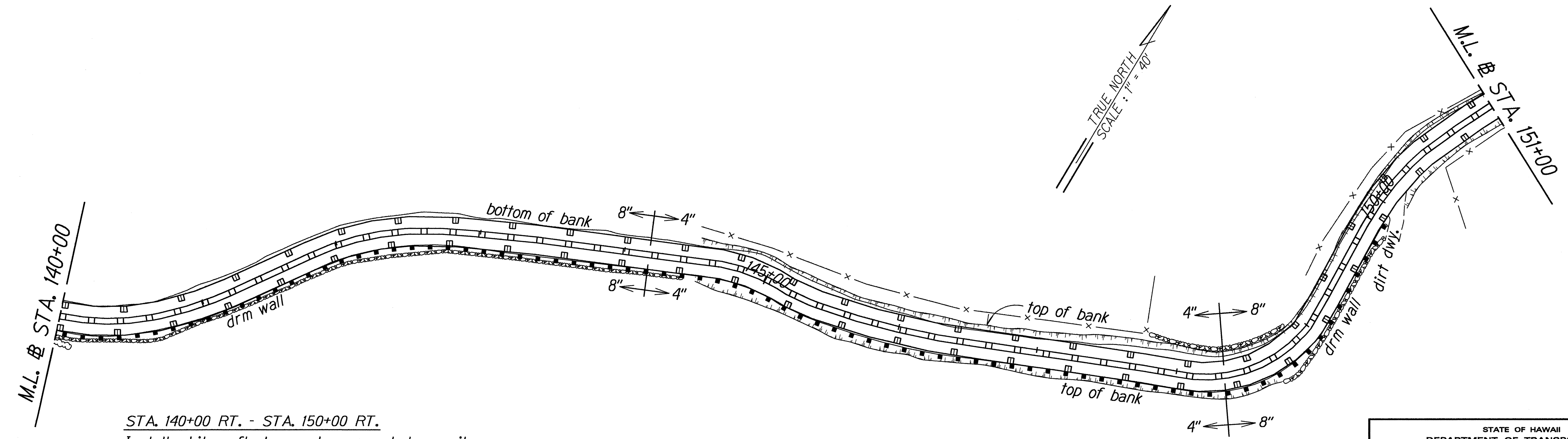

STA. 140+00 RT. - STA. 150+00 RT.
Install white reflector markers mounted on rail element @ 50' o.c.

ORIGINAL PLAN	DATE
DESIGNED BY C. HANAKA	APRIL 1994
CHECKED BY	
DRAWN BY J. GALERAO	
REVISIONS	

STATE OF HAWAII
DEPARTMENT OF TRANSPORTATION
HIGHWAYS DIVISION
SIGNING & PAVEMENT
MARKING PLAN
KAMEHAMEHA V HIGHWAY RESURFACING
Kilohana School to Waialua
Project No. 450B-01-94M
Scale: 1" = 40' Date: May, 1994
SHEET No. 7 OF 12 SHEETS

FED. ROAD DIST. NO.	STATE	PROJ. NO.	FISCAL YEAR	SHEET NO.	TOTAL SHEETS
HAWAII	HAW.	450B-01-94M	1994	26	31

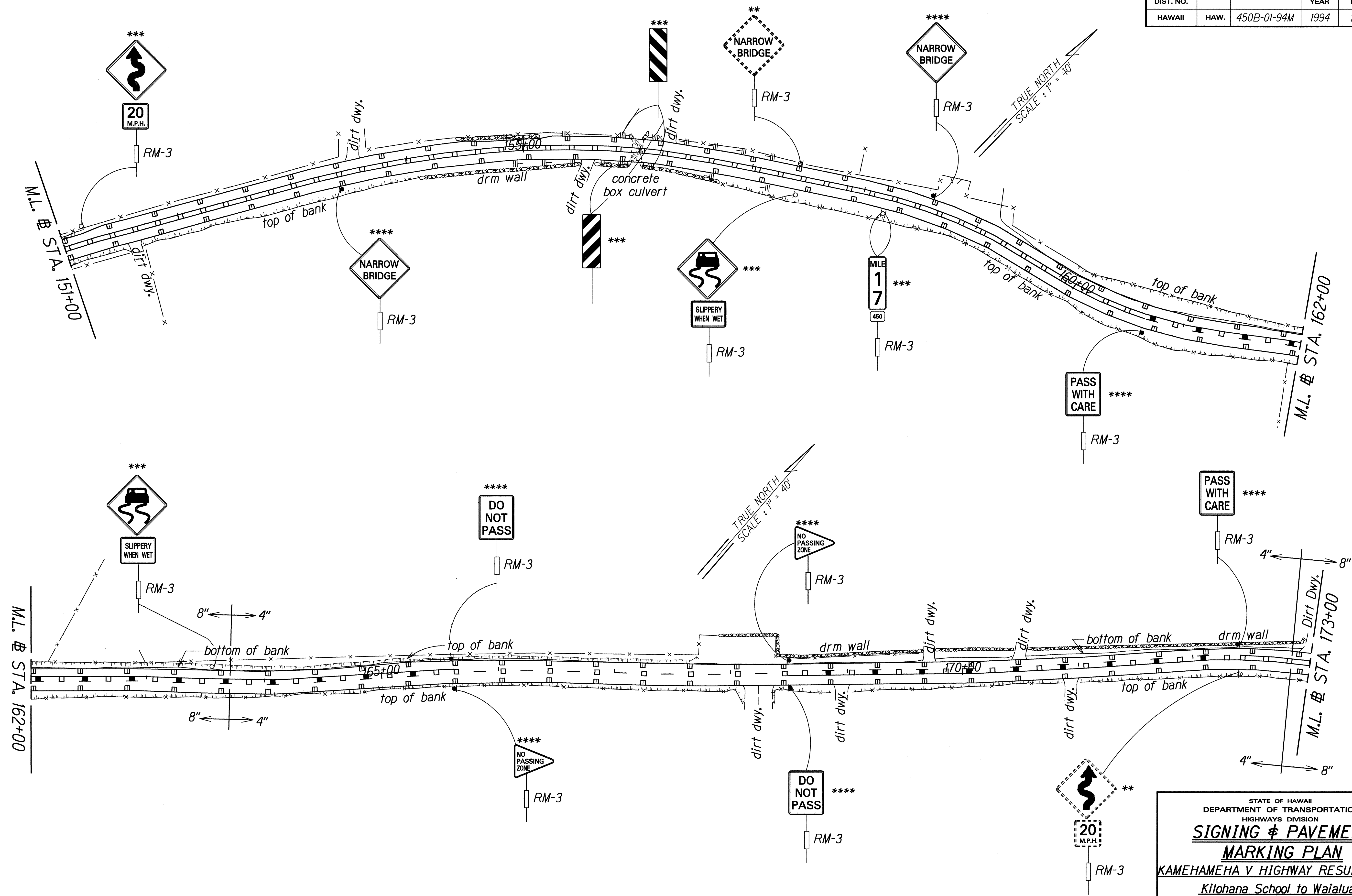

DATE	APRIL 1994
DESIGNED BY	C. HANABUSA
CHECKED BY	
TRACED BY	
DRAWN BY	
REVISIONS	
ORIGINAL PLAN	

STATE OF HAWAII
DEPARTMENT OF TRANSPORTATION
HIGHWAYS DIVISION

SIGNING & PAVEMENT MARKING PLAN

KAMEHAMEHA V HIGHWAY RESURFACING
Kilohana School to Waialua
Project No. 450B-01-94M

Scale: 1" = 40' Date: May, 1994

SHEET No. 8 OF 12 SHEETS

FED. ROAD DIST. NO.	STATE	PROJ. NO.	FISCAL YEAR	SHEET NO.	TOTAL SHEETS
HAWAII	HAW.	450B-01-94M	1994	27	31

STA. 178+00 LT. - STA. 179+50 LT.
Install RM-2 @ 50' o.c. (bi-directional)

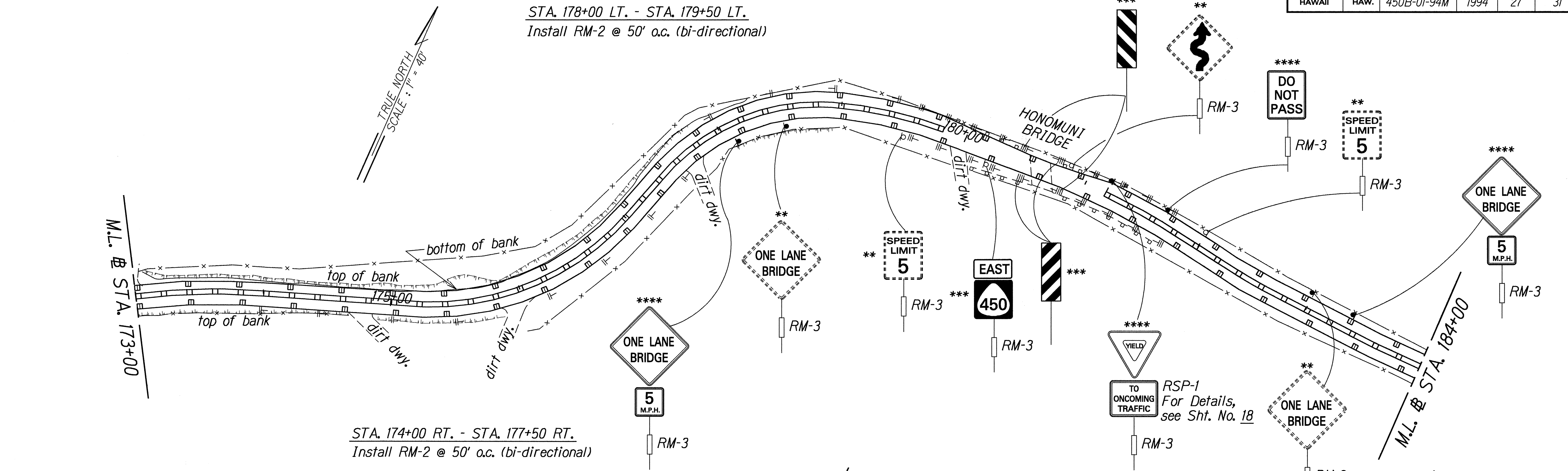

STA. 174+00 RT. - STA. 177+50 RT.
Install RM-2 @ 50' o.c. (bi-directional)

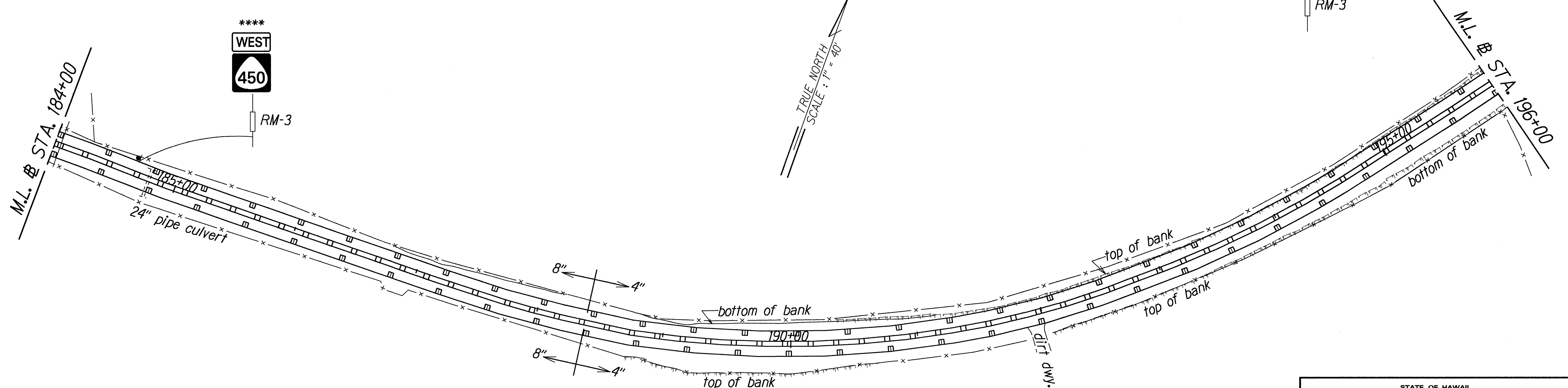

DATE	April 1994
SURVEY PLOTTED BY	J. Guzman
DRAWN BY	J. Guzman
TRACED BY	J. Guzman
DESIGNED BY	C. Bowers
QUANTITIES BY	
CHECKED BY	

STATE OF HAWAII
DEPARTMENT OF TRANSPORTATION
HIGHWAYS DIVISION

**SIGNING & PAVEMENT
MARKING PLAN**

KAMEHAMEHA V HIGHWAY RESURFACING
Kilohana School to Waialua
Project No. 450B-01-94M
Scale: 1" = 40' Date: May, 1994

SHEET No. 9 OF 12 SHEETS

FED. ROAD DIST. NO.	STATE	PROJ. NO.	FISCAL YEAR	SHEET NO.	TOTAL SHEETS
HAWAII	HAW.	450B-01-94M	1994	28	31

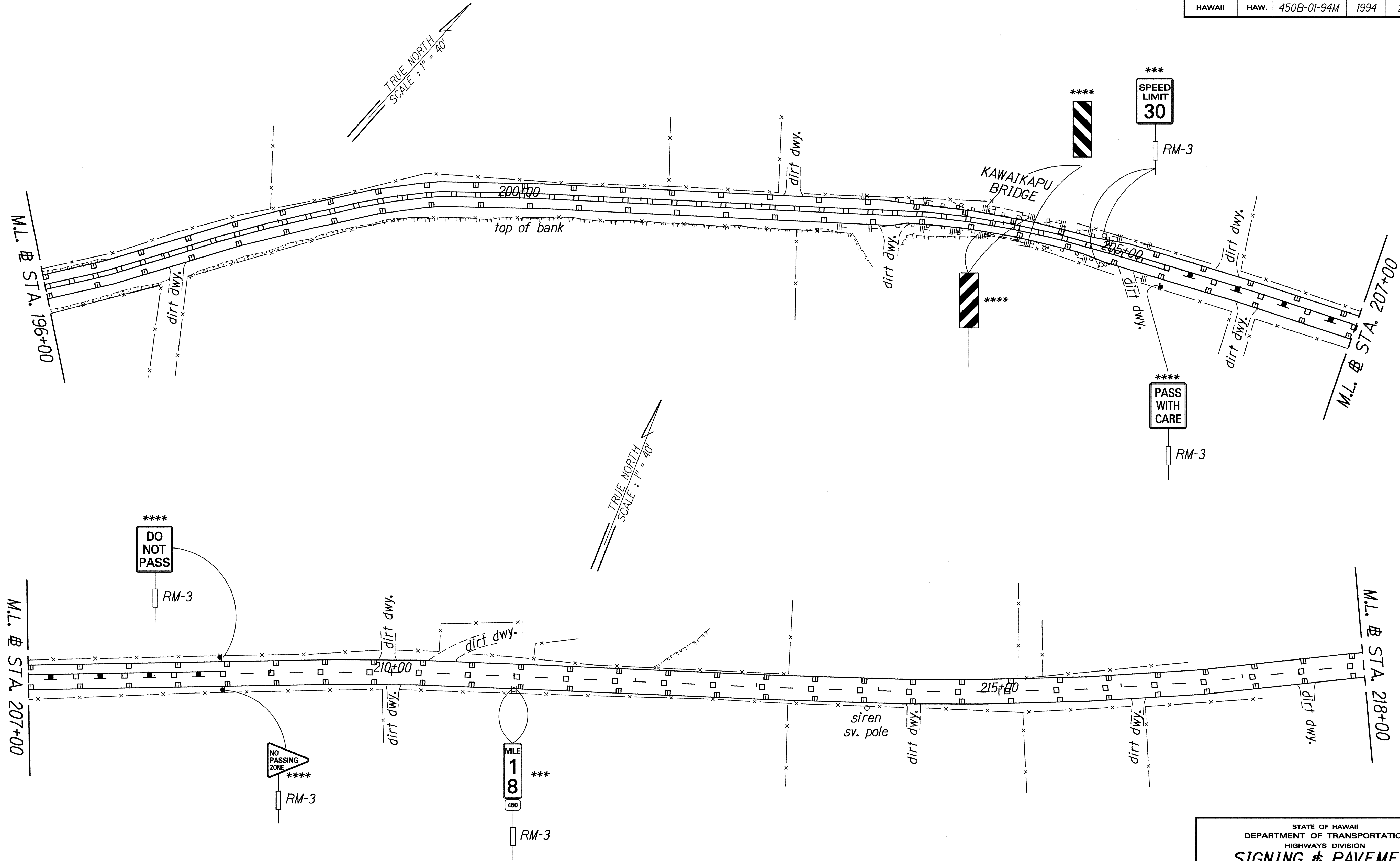

ORIGINAL PLAN
 SURVEY PLOTTED BY DATE
 DRAWN BY J. Guzman
 DESIGNED BY C. Pangaea
 QUANTITIES BY
 CHECKED BY

STATE OF HAWAII
 DEPARTMENT OF TRANSPORTATION
 HIGHWAYS DIVISION
SIGNING & PAVEMENT
MARKING PLAN
 KAMEHAMEHA V HIGHWAY RESURFACING
 Kilohana School to Waialua
 Project No. 450B-01-94M
 Scale: 1" = 40' Date: May, 1994
 SHEET No. 10 OF 12 SHEETS

FED. ROAD DIST. NO.	STATE	PROJ. NO.	FISCAL YEAR	SHEET NO.	TOTAL SHEETS
HAWAII	HAW.	450B-01-94M	1994	29	31

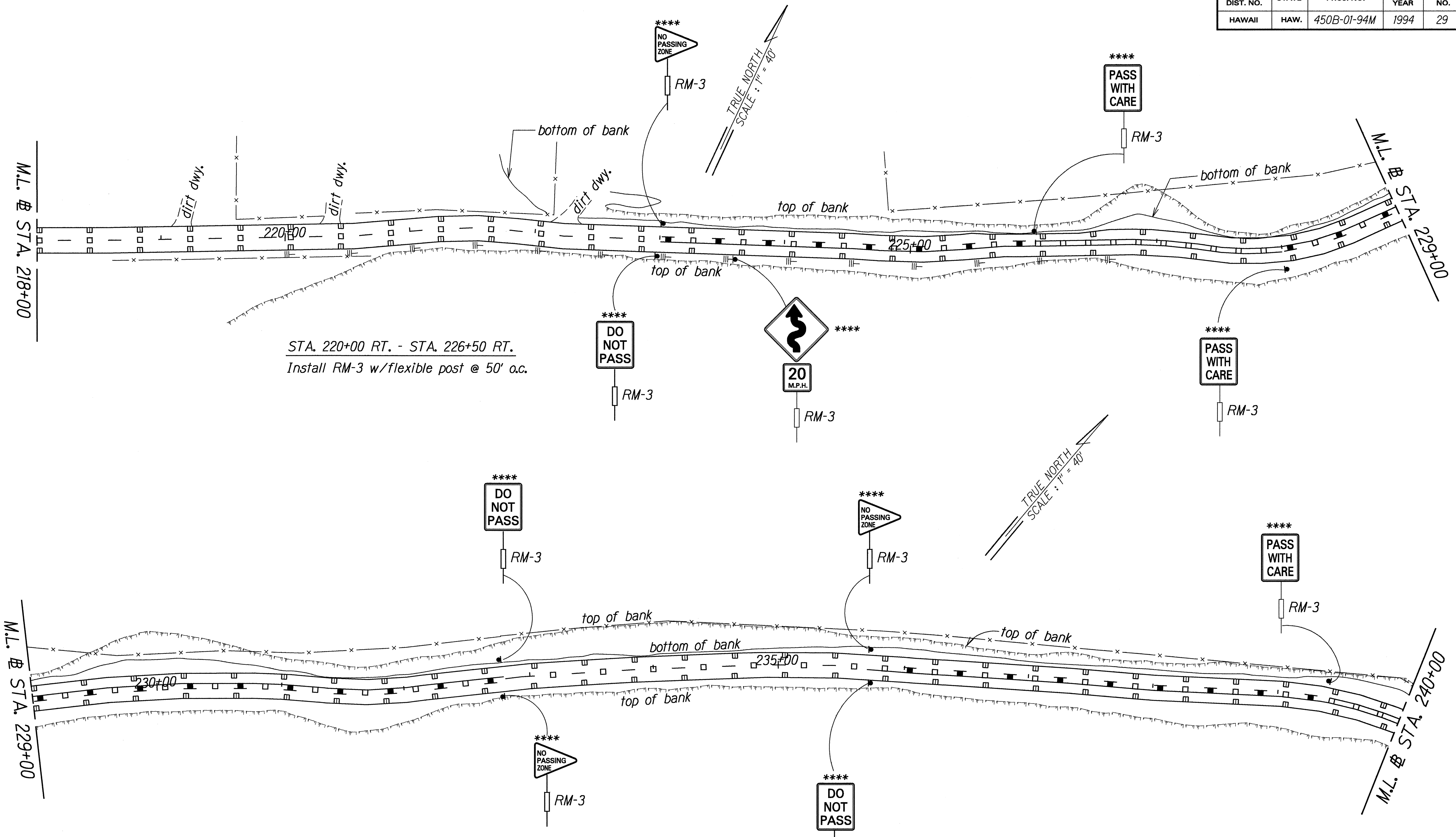

STA. 220+00 RT. - STA. 226+50 RT.
Install RM-3 w/flexible post @ 50' o.c.

ORIGINAL PLAN	DATE
DRAWN BY	
DESIGNED BY	
CHECKED BY	

STATE OF HAWAII
DEPARTMENT OF TRANSPORTATION
HIGHWAYS DIVISION

**SIGNING & PAVEMENT
MARKING PLAN**

KAMEHAMEHA V HIGHWAY RESURFACING

Kilohana School to Waialua
Project No. 450B-01-94M

Scale: 1" = 40' Date: May, 1994

SHEET No. 11 OF 12 SHEETS

FED. ROAD DIST. NO.	STATE	PROJ. NO.	FISCAL YEAR	SHEET NO.	TOTAL SHEETS
HAWAII	HAW.	450B-01-94M	1994	30	31

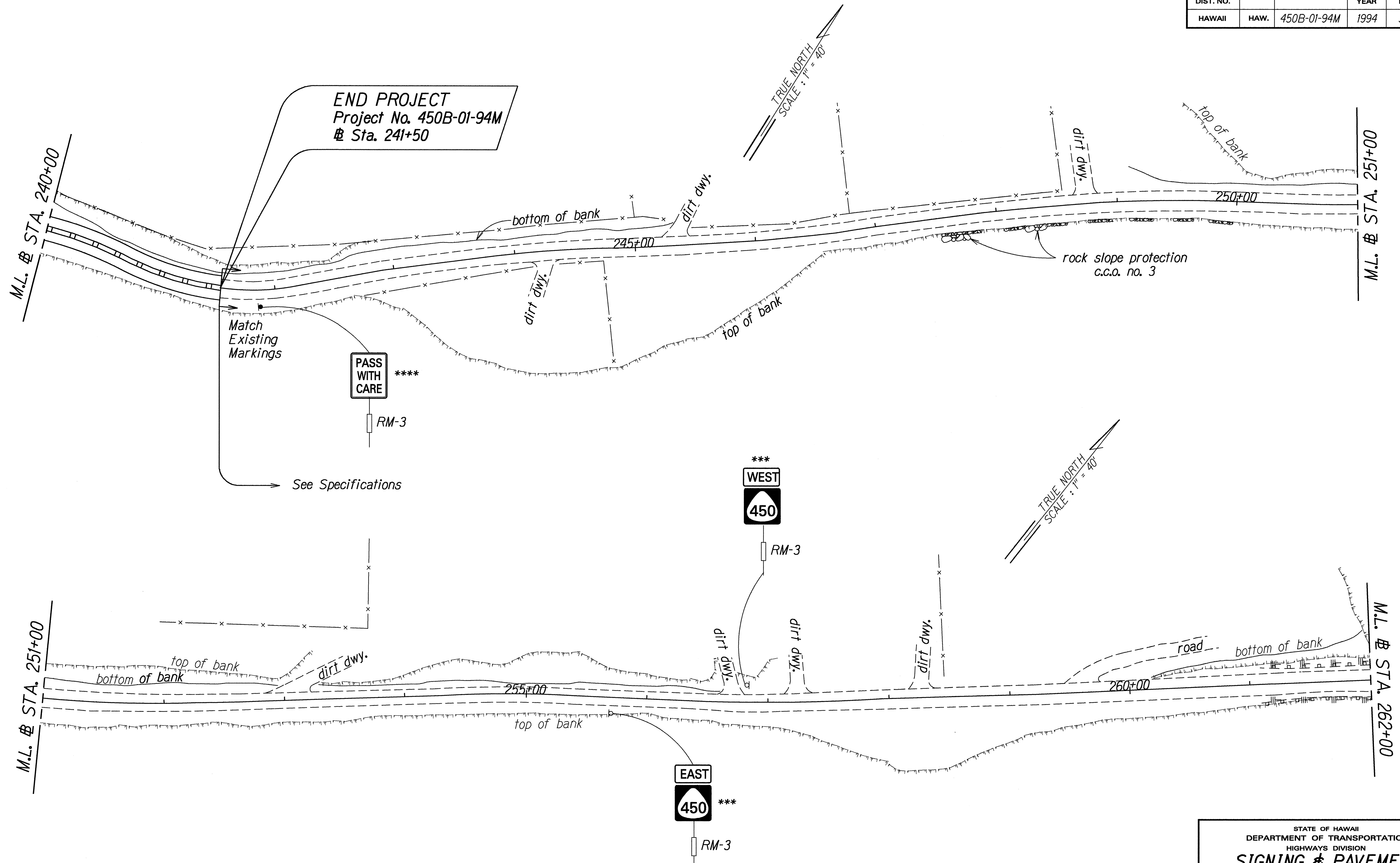

END PROJECT
Project No. 450B-01-94M
Sta. 241+50

PASS WITH CARE ****
RM-3

WEST
450
RM-3

EAST
450 ***
RM-3

ORIGINAL PLAN	DATE
DESIGNED BY	April 1994
TRACED BY	
DESIGNED BY	
QUANTITIES BY	
CHECKED BY	

STATE OF HAWAII
DEPARTMENT OF TRANSPORTATION
HIGHWAYS DIVISION
SIGNING & PAVEMENT MARKING PLAN
KAMEHAMEHA V HIGHWAY RESURFACING
Kilohana School to Waialua
Project No. 450B-01-94M
Scale: 1" = 40' Date: May, 1994
SHEET No. 12 OF 12 SHEETS