

FED. ROAD DIST. NO.	STATE	FED. AID PROJ. NO.	FISCAL YEAR	SHEET NO.	TOTAL SHEETS
HAWAII	HAW.	50E-04-68 50E-05-69	1969	19	27

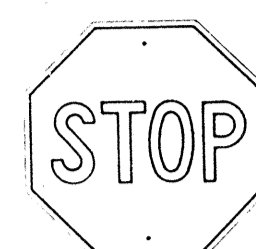

R1-1 30"x 30"

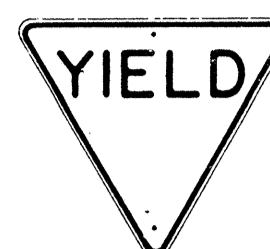

R1-2 36"x36"x36"
R1-2-E 48"x48"x48"
R1-2-I 60"x60"x60"

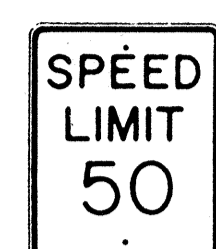

R2-1(50) 24"x 30"
R2-1(50)-E 36"x48"
R2-1(50)-I 48"x60"

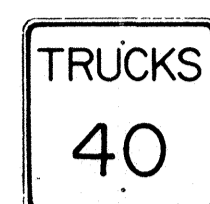

R2-2(40) 24"x 24"
R2-2(40)-E 36"x36"
R2-2(40)-I 48"x48"

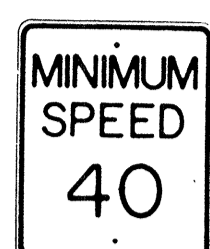

R2-4(40) 24"x 30"
R2-4(40)-E 36"x48"
R2-4(40)-I 48"x60"



R2-5 24"x 30"
R2-5-E 36"x48"
R2-5-I 48"x60"

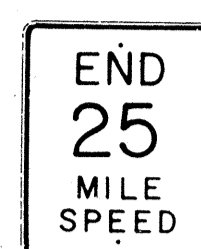

R2-6(25) 24"x 30"
R2-6(25)-E 36"x48"
R2-6(25)-I 48"x60"



R2-7 24"x 30"
R2-7-E 36"x48"
R2-7-I 48"x60"

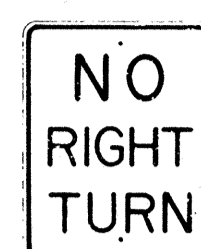

R3-1 24"x 30"
R3-1-E 36"x48"



R3-2 24"x 30"
R3-2-E 36"x48"



R3-3 24"x 24"

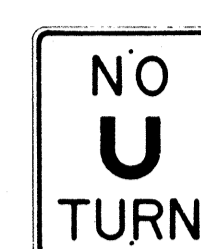

R3-4 24"x 30"
R3-4-E 36"x48"
R3-4-I 48"x60"

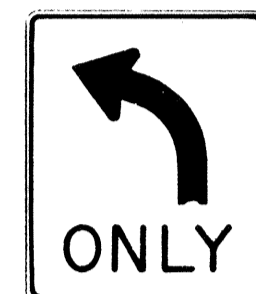

R3-5(L) 30"x 36"

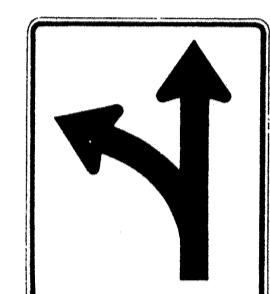

R3-6(L) 30"x 36"

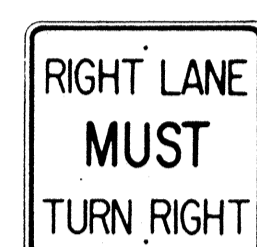

R3-7(R) 30"x 30"

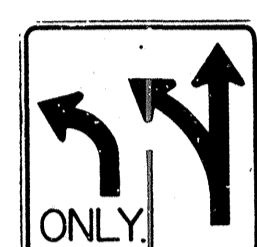

R3-8(L) 30"x 30"



R4-1 24"x 30"



R4-2 24"x 30"



R4-3 24"x 30"
R4-3-E 36"x48"
R4-3-I 48"x60"

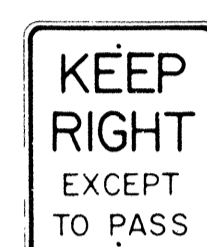

R4-4 24"x 30"
R4-4-E 36"x48"
R4-4-I 48"x60"

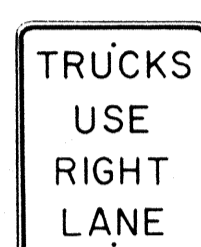

R4-5 24"x 30"
R4-5-E 36"x48"



R4-6 24"x 30"
R4-6-E 36"x48"



R4-7(R) 24"x 30"
R4-7(R)-E 36"x48"

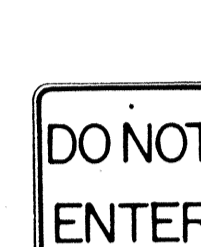

R5-1 24"x 24"



R6-1(R) 36"x 12"



R6-2(R) 18"x 24"

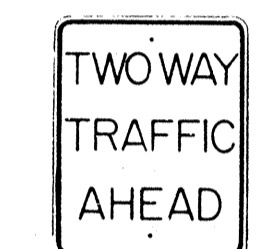

R6-3 24"x 30"



R6-4 24"x 30"

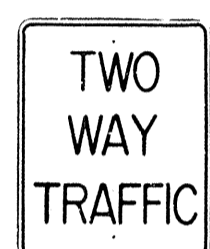

R6-5 24"x 30"



R7-1 12"x 18"

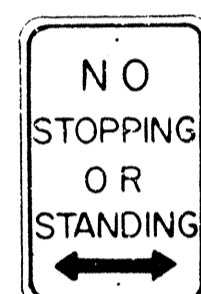

R7-4 12"x 18"
R7-4-E 24"x30"

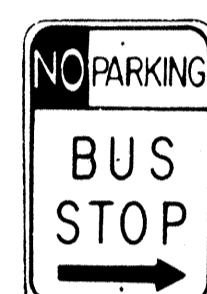

R7-107(R) 12"x18"

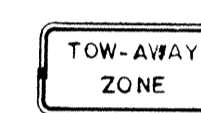

R7-201 12"x 6"



R8-1 24"x30"
R8-1-E 36"x48"
R8-1-I 48"x60"



R8-2 24"x30"
R8-2-E 36"x48"



R8-3 24"x 30"
R8-3-E 36"x48"



R8-4 24"x30"
R8-4-E 36"x48"
R8-4-I 48"x36"

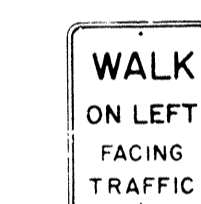

R9-1 18"x24"

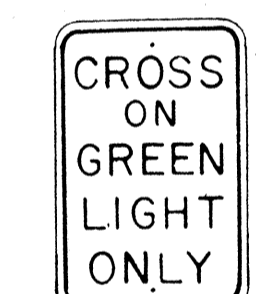

R9-2 12"x 18"



R9-3 12"x 18"

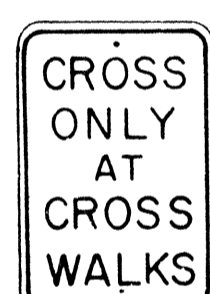

R9-4 12"x18"

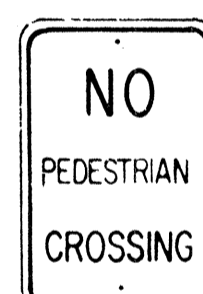

R9-5 12"x18"

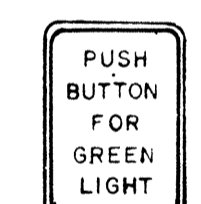

R9-6 9"x 12"

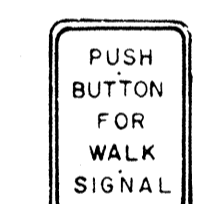

R9-7 9"x 12"

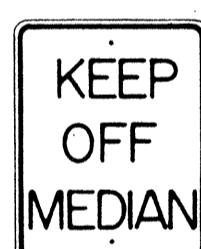

R10-1 24"x30"
R10-1-E 36"x48"
R10-1-I 48"x60"



R10-2 48"x 30"

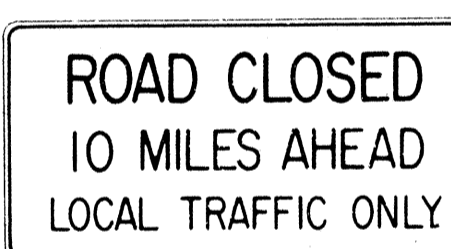

R10-3(10) 60"x 30"

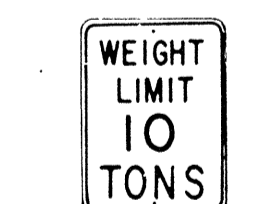

R10-4(10) 18"x24"

NOTE:

1. The shape, color, dimensions, symbols, wording, lettering and reflectorization of all signs shall be in accordance with the "Manual on Uniform Traffic Control Devices for Streets and Highways," dated June 1961 and the BPR manual "Standard Highway Signs," dated September 1961 unless otherwise specified.
2. All regulatory signs shall be reflectorized unless otherwise specified.
3. All regulatory signs shall have 3/8" bolt holes drilled at appropriate locations unless otherwise noted.
4. The suffix "E" denotes Expressway signs and "I" denotes Interstate signs.
5. For R2 signs, number in () indicates speed and shall be as shown on the plans.
6. (R) or (L) indicates right or left and shall be as shown on the plans.
7. For R10-4 sign, number in () indicates weight and shall be as shown on the plan.











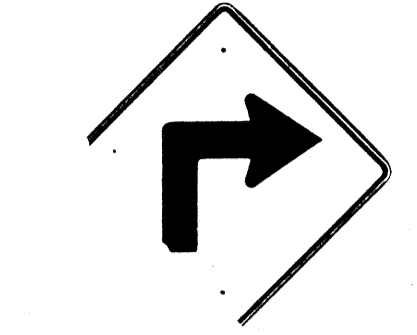
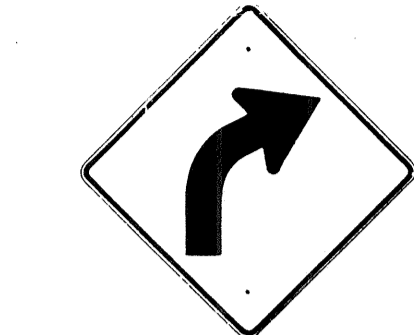
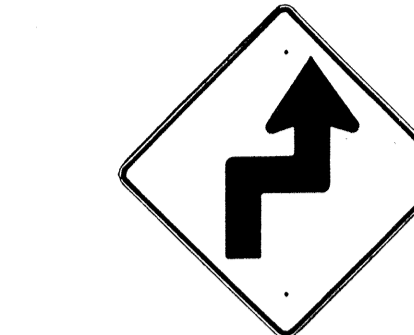
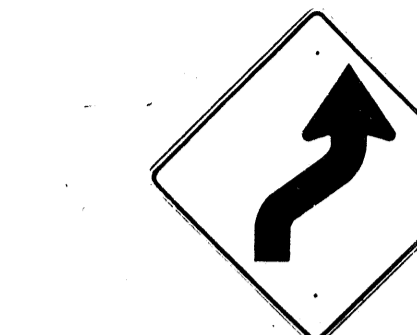

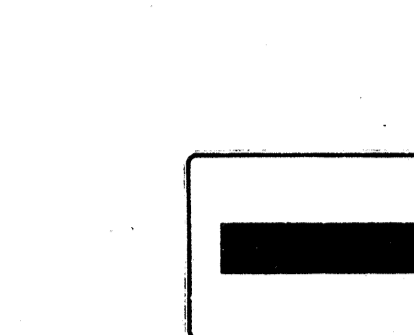
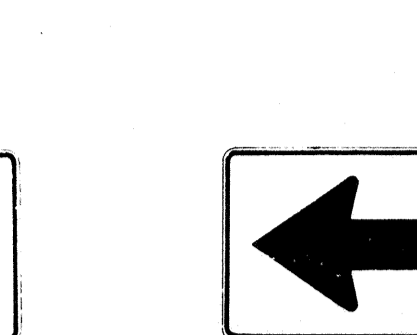
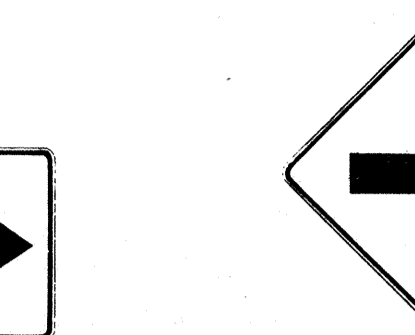
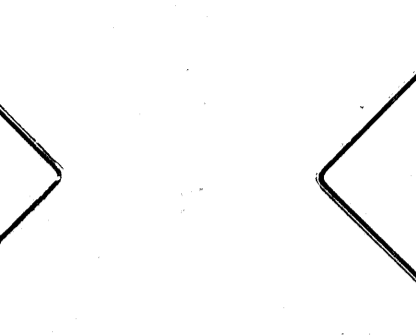
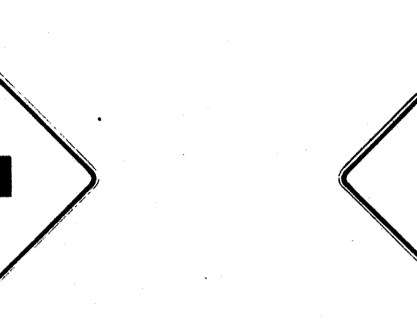
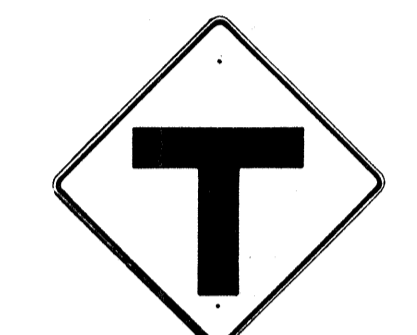
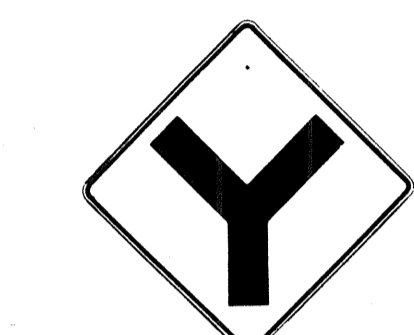



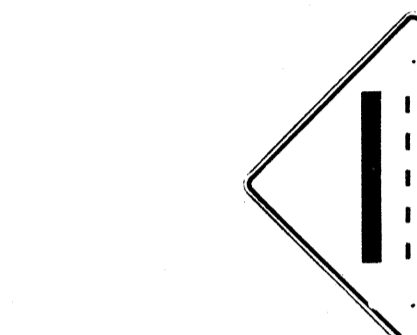

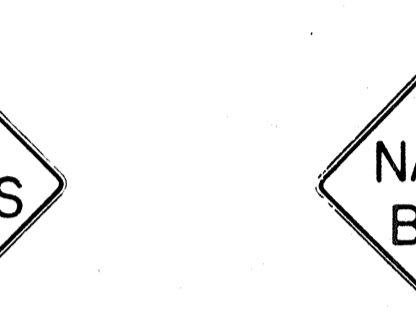
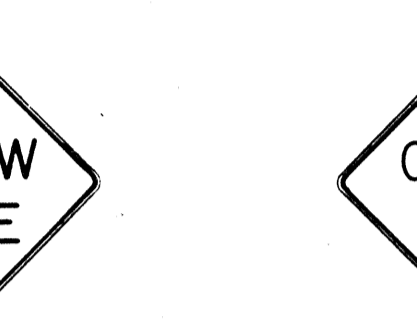



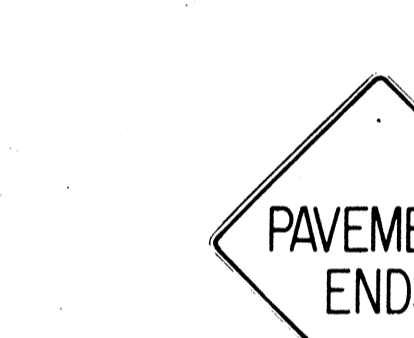

ORIGINAL PLAN	SURVEY PLOTTED BY	DATE
DESIGNED BY	DRAWN BY	
CHECKED BY	NOTED BY	
QUANTITIES BY		

STATE OF HAWAII
DEPARTMENT OF TRANSPORTATION
HIGHWAYS DIVISION

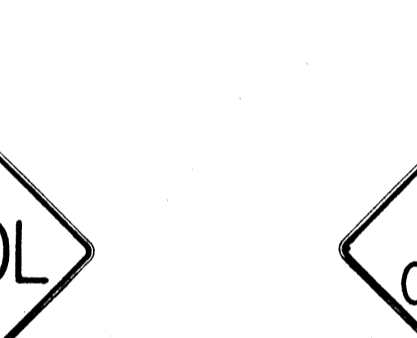
STANDARD DETAILS
REGULATORY SIGNS

NOT TO SCALE

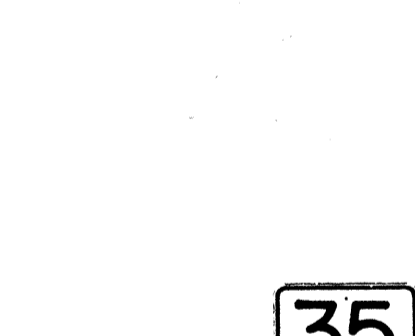
FED. ROAD DIST. NO.	STATE	FED. AID PROJ. NO.	FISCAL YEAR	SHEET NO.	TOTAL SHEETS
HAWAII	HAW.	50E-04-68 50E-05-68	1967	20	27

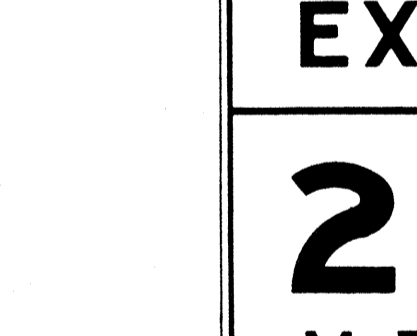
 WI-1(R) 30" x 30"	 WI-2(R) 30" x 30"	 WI-3(R) 30" x 30"	 WI-4(R) 30" x 30"	 WI-5(R) 30" x 30"	 WI-6 48" x 24"	 WI-7 48" x 24"	 W2-1 30" x 30"	 W2-2 30" x 30"	 W2-3(R) 30" x 30"
 W2-4 30" x 30"	 W2-5 30" x 30"	 W3-1 30" x 30"	 W3-2 30" x 30"	 W3-3 36" x 36"	 W4-1 30" x 30" W4-1-E 36" x 36" W4-1-I 48" x 48"	 W4-2 30" x 30" W4-2-E 36" x 36"	 W5-1 30" x 30" W5-1-E 36" x 36"	 W5-2 30" x 30"	 W5-3 30" x 30"
 W6-1 36" x 36"	 W6-2 36" x 36"	 W7-1 30" x 30"	 W8-1 30" x 30"	 W8-2 30" x 30"	 W8-3 30" x 30"	 W8-4 30" x 30"	 W8-5 30" x 30"	 W9-1 30" x 30"	 W9-2 30" x 30"
 W10-1 36" DIAMETER	 W11-1 30" x 30"	 W11-5 30" x 30"	 W12-2 36" x 36"	 W13-1(35) 18" x 18" W13-1(35)-E 24" x 24"	 W13-2(25) 12" x 18"	 W13-3(25) 48" x 60"			

- NOTE:
- The shape, color, dimensions, symbols, wording, lettering and reflectorization of all signs shall be in accordance with the "Manual on Uniform Traffic Control Devices for Streets and Highways," dated June 1961 and the BPR manual "Standard Highway Signs," dated September 1961 unless otherwise specified.
 - All warning signs shall be reflectorized unless otherwise specified.
 - All warning signs shall have 3/8" bolt holes drilled at appropriate locations unless otherwise noted.
 - (R) or (L) indicates right or left and shall be as shown on the plan.
 - The suffix "E" denotes Expressway signs and "I" denotes Interstate signs.
 - For W13 sign, number in () indicates speed and shall be as shown on the plans.

DATE: _____
 DESIGNED BY: _____
 CHECKED BY: _____
 NO. _____

REVISED: September 26, 1967

STATE OF HAWAII
 DEPARTMENT OF TRANSPORTATION
 HIGHWAYS DIVISION

STANDARD DETAILS
WARNING SIGNS

NOT TO SCALE

SHEET No. 3 OF 5 SHEETS DT 102

20

FED. ROAD DIST. NO.	STATE	PROJ. NO.	FISCAL YEAR	SHEET NO.	TOTAL SHEETS
HAWAII	HAW.	50E-04-68 50E-05-69	1969	21	27

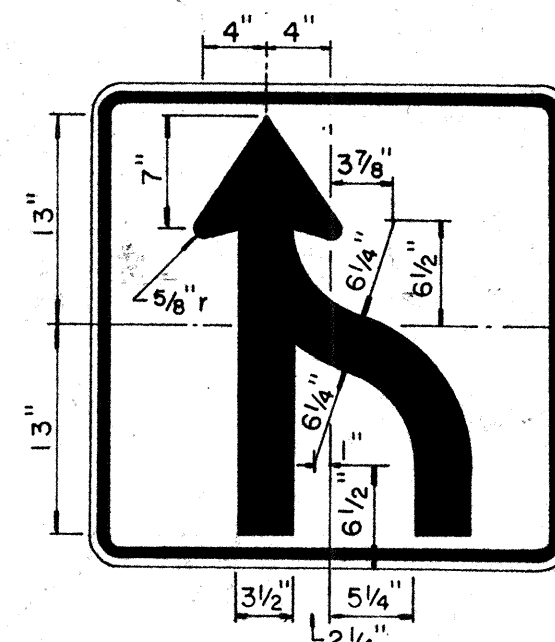

R3-9 30" x 30"

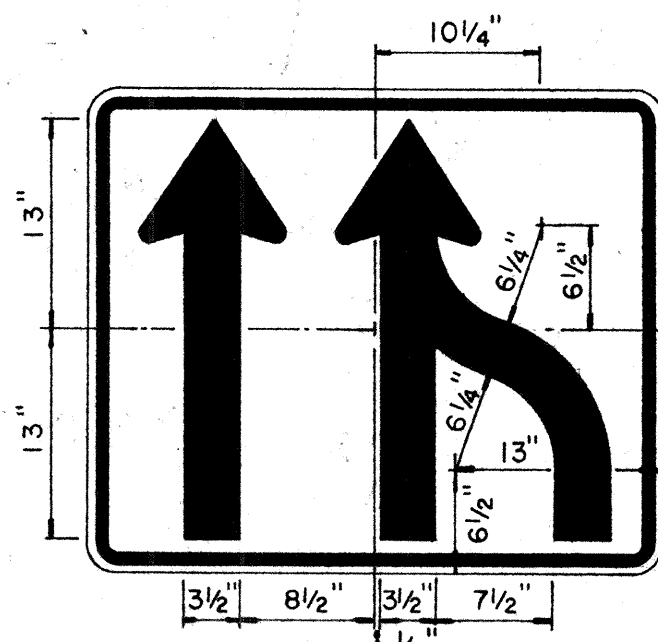

R3-10 36" x 30"

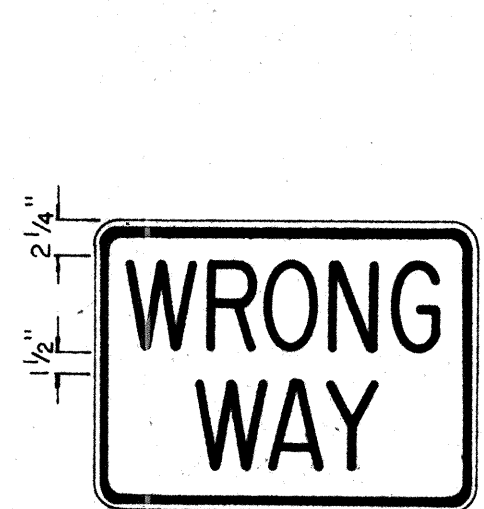

R5-5(1) 24" x 18"
R5-5(2) 36" x 24"

NOTE:
White legend and border
on Red background

6" Series C: R5-5(1)
8" Series C: R5-5(2)

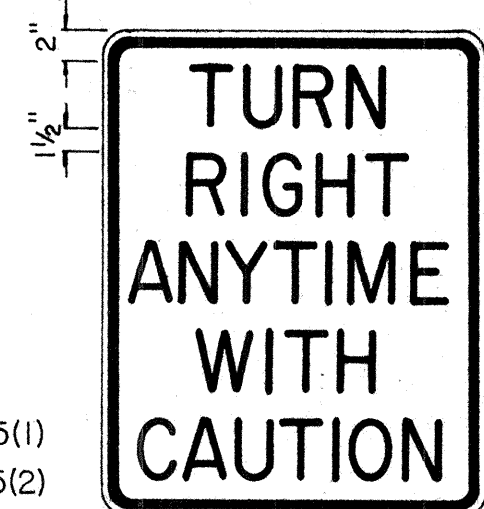

R15-1 24" x 30"

4" Series C

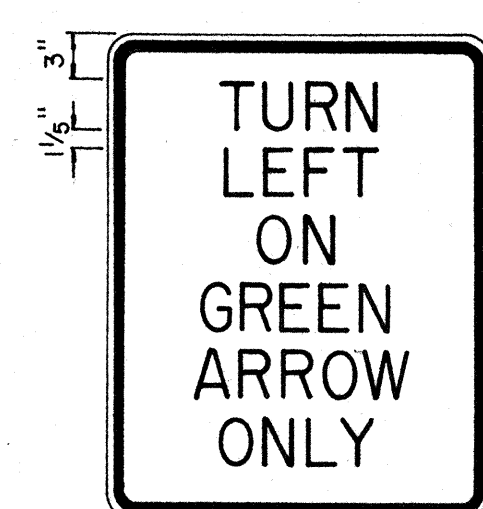

R16-1 24" x 30"

3" Series C

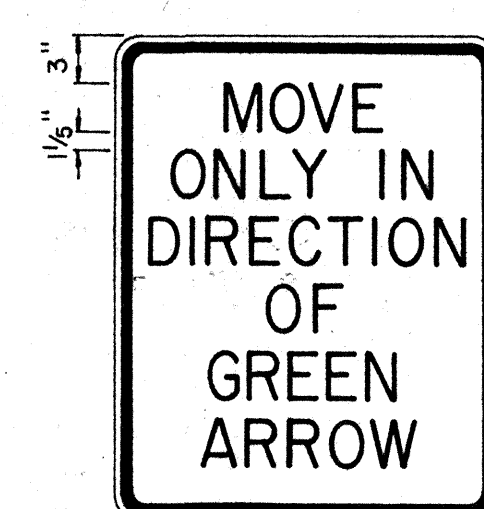

R16-2 24" x 30"

3" Series C

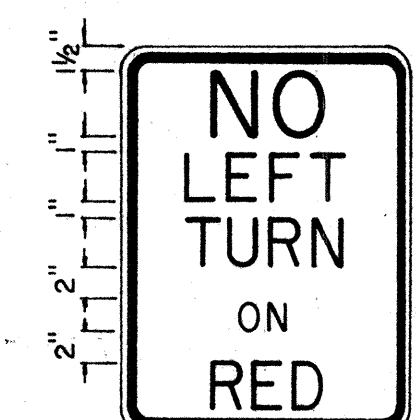

R17-1 18" x 24"

4" Series D
3" Series C
2" Series B

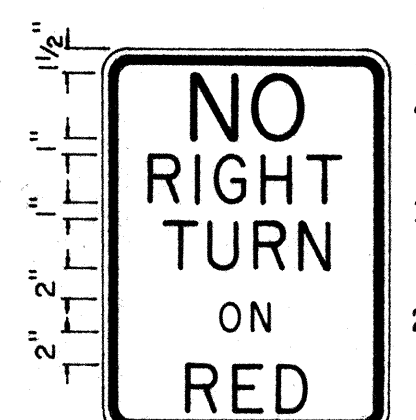

R17-2 18" x 24"

4" Series D
3" Series C
2" Series B

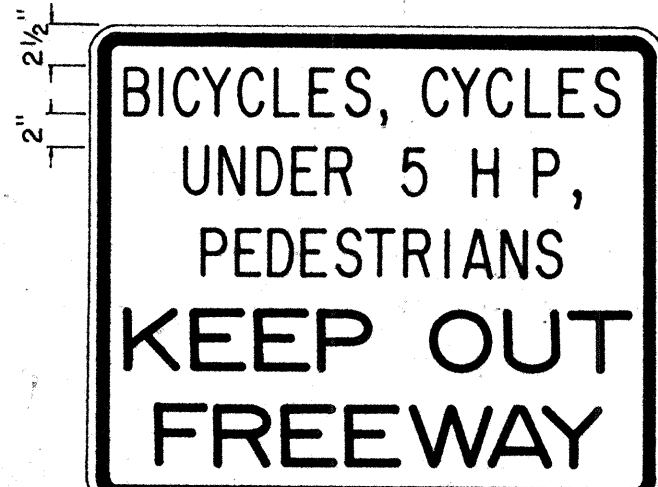

R18-1 36" x 30"

3" Series C

4" Series E

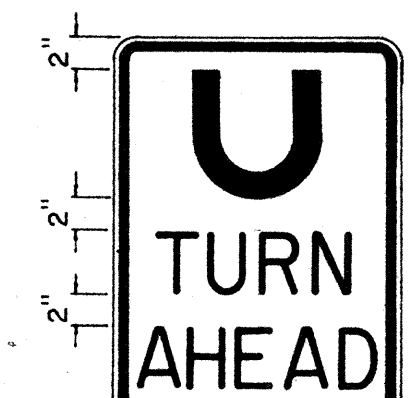

R19-1 18" x 24"

8" Series F

4" Series D



W13-4 24" x 24"

3" Series D

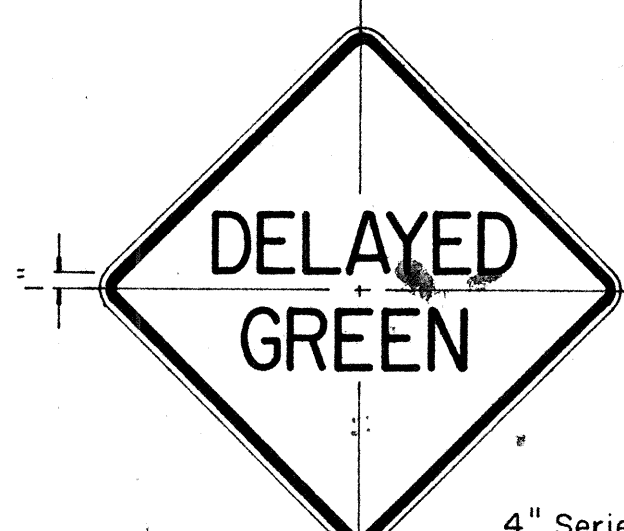

W15-1 24" x 24"

4" Series C

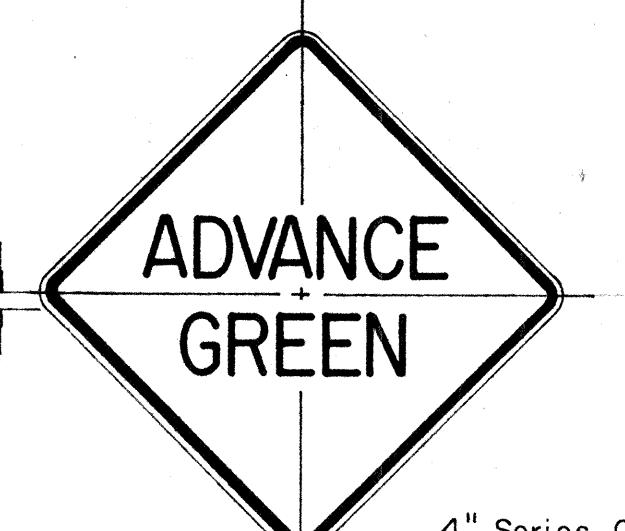

W15-2 24" x 24"

4" Series C

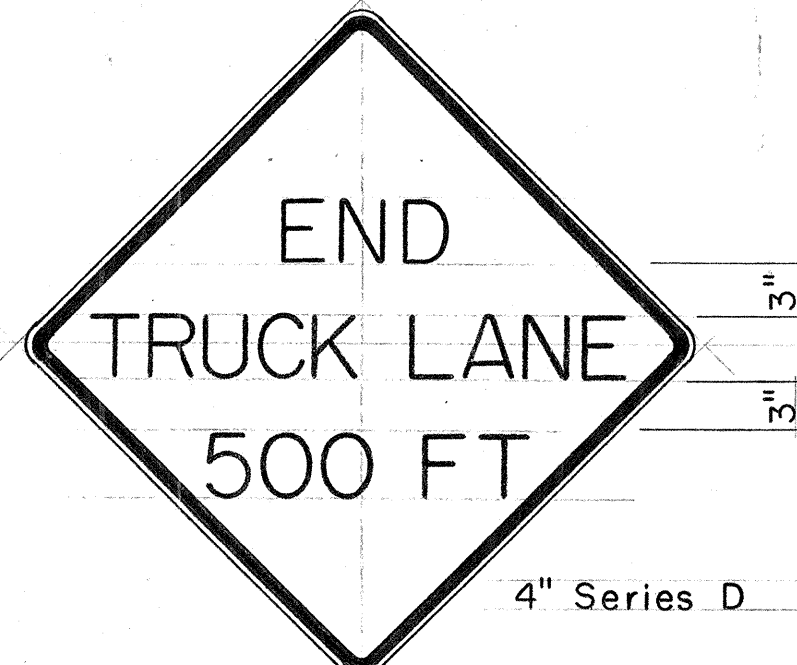

W6-3 30" x 30"

4" Series D

NOTE:

- The shape, color, plate details, lettering and reflectorization of Regulatory signs (Prefix R) and Warning signs (Prefix W) shall be in accordance with the "Manual on Uniform Traffic Control Devices for Streets and Highways," dated June 1961 and the BPR manual "Standard Highway Signs," dated September 1961 unless otherwise specified.
- All regulatory and warning signs shall be reflectorized unless otherwise specified.
- All regulatory and warning signs shall have 3/8" bolt holes drilled at appropriate locations unless otherwise specified.

DATE	_____
SURVEY PLOTTED BY	_____
DESIGNED BY	_____
PLACED BY	_____
QUANTITIES BY	_____
CHECKED BY	_____
ORIGINAL PLAN	_____
NOTE BOOK	_____
No.	_____

STATE OF HAWAII
DEPARTMENT OF TRANSPORTATION
HIGHWAYS DIVISION

STANDARD DETAILS

MISCELLANEOUS
REGULATORY & WARNING SIGNS

Scale: 1" = 1'-0"

SHEET No. 4 OF 5 SHEETS

FED. ROAD DIST. NO.	STATE	PROJ. NO.	FISCAL YEAR	SHEET NO.	TOTAL SHEETS
HAWAII	HAW.	50E-04-28 50E-05-60	1969	22	27

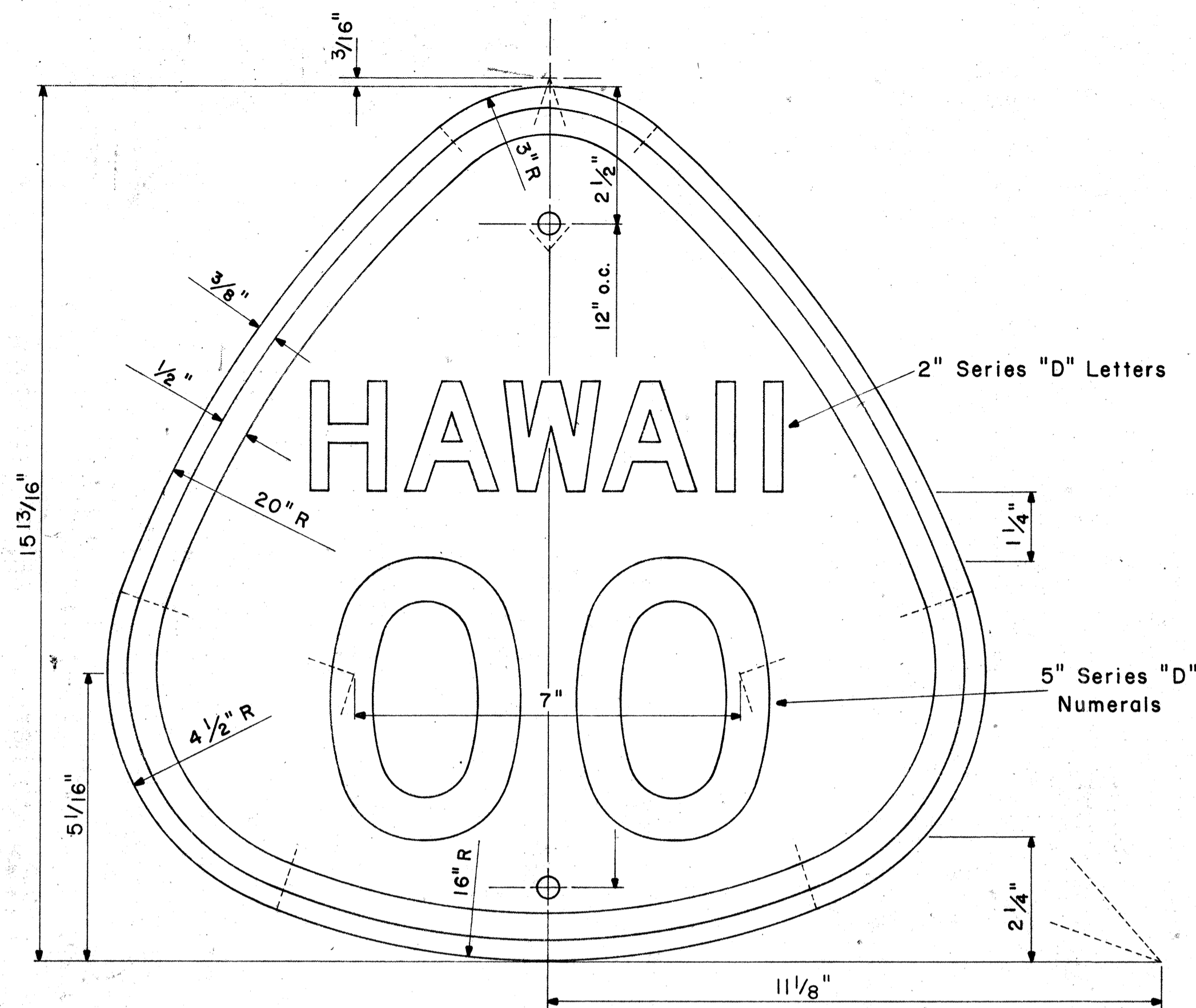

STATE ROUTE MARKER
MI-3(00)

Scale: 1/2" = 1"

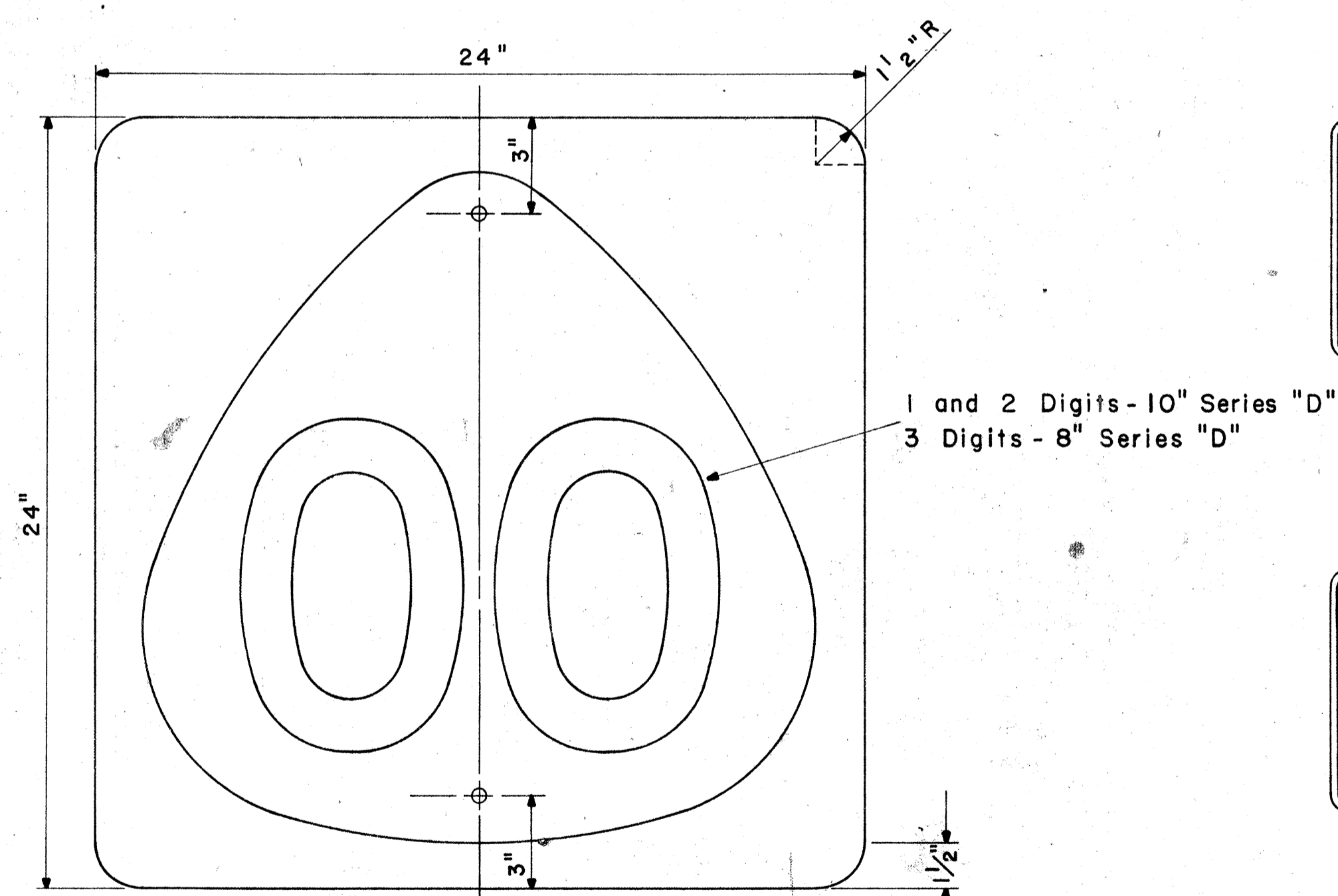

STATE ROUTE MARKER
MI-4(00)

Scale: 1/4" = 1"

NOTE:
Multiply all dimensions of State Route Marker MI-3 by 1.3 for the dimensions of the shield for MI-4.

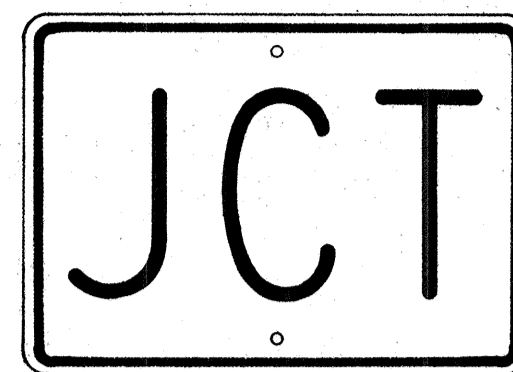

M2-1
21" x 15"

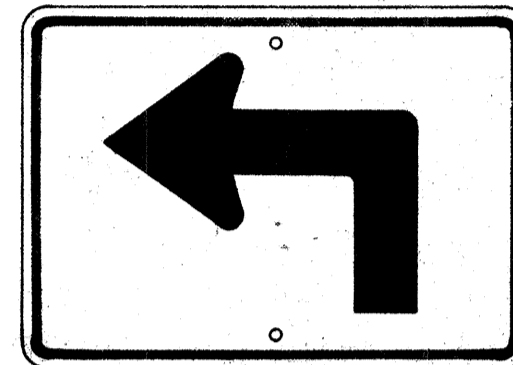

M3-1-L
* M3-1-R
21" x 15"

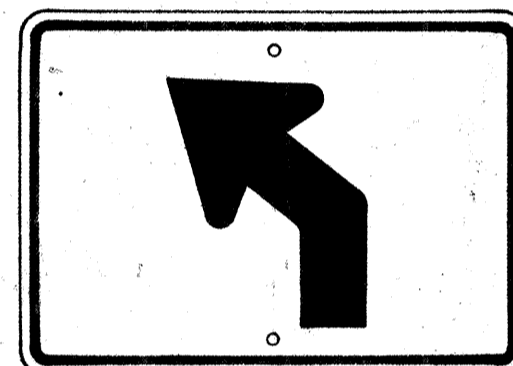

M3-2-L
* M3-2-R
21" x 15"

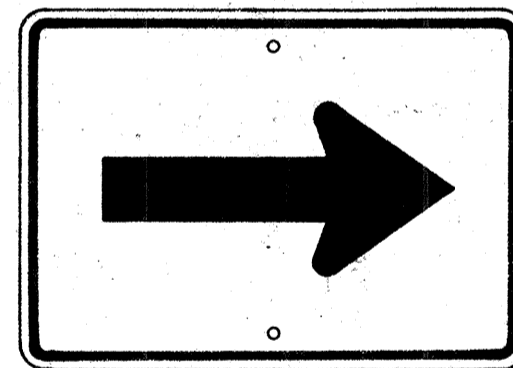

M4-1
21" x 15"

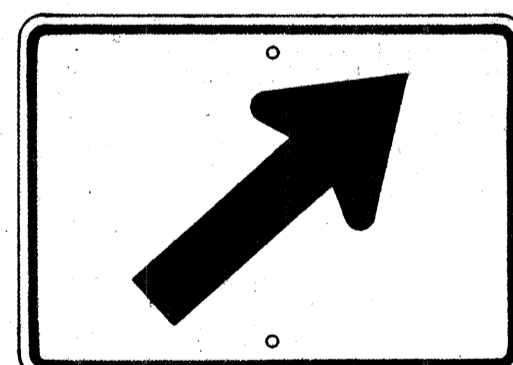

M4-2-R
* M4-2-L
21" x 15"

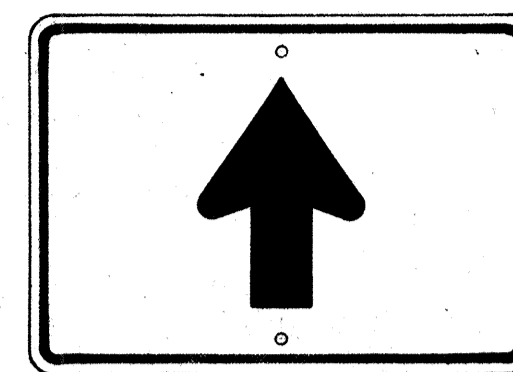

M4-3
21" x 15"

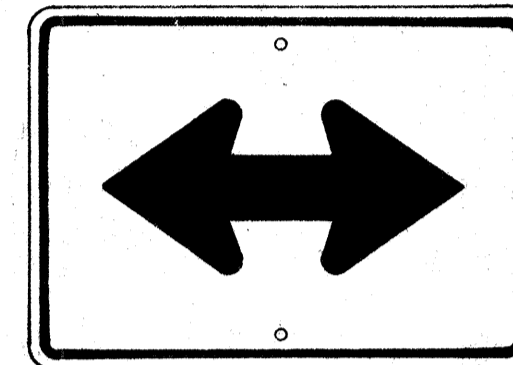

M4-4
21" x 15"

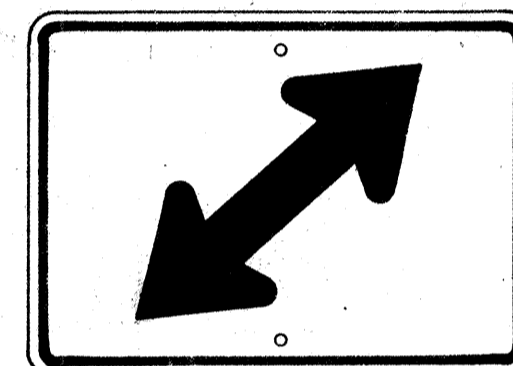

M4-5-R
* M4-5-L
21" x 15"

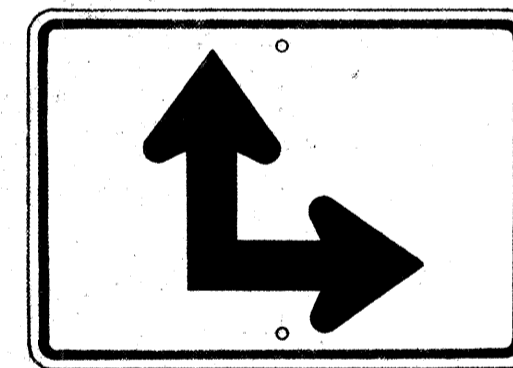

M4-6-R
* M4-6-L
21" x 15"

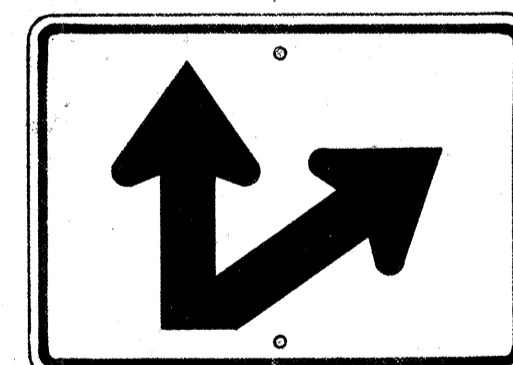

M4-7-R
* M4-7-L
21" x 15"

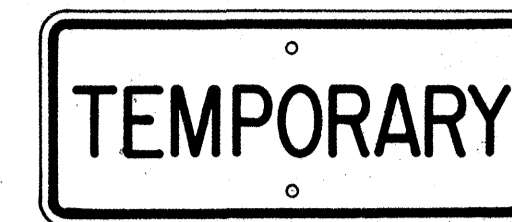

M5-1
21" x 9"



M5-2
21" x 9"

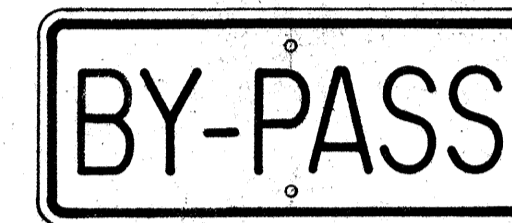

M5-3
21" x 9"



M5-4
21" x 9"



M5-5
21" x 9"



M5-6
21" x 9"

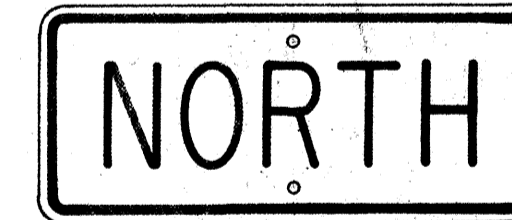

M6-1-N
21" x 9"
(See Note 6)



M7-1
18" x 12"

AUXILIARY MARKERS

Scale: 1/8" = 1"

* NOTE:
Signs shall be similar but opposite in direction.

GENERAL NOTES

- The shape, color, dimensions, symbols, wording, lettering and reflectorizing of all signs shall be in accordance with the "Manual on Uniform Traffic Control Devices for Streets and Highways," dated June 1961 and the BPR manual "Standard Highway Signs," dated September 1961, unless otherwise specified.
- All letters and figures shall conform to the manual "Standard Alphabets for Highway Signs," Dept. of Commerce, Bureau of Public Roads, 1952.
- All markers shall be reflectorized unless otherwise specified.
- All markers shall have 3/8" bolt holes drilled at appropriate locations unless otherwise specified.
- All markers shall have a black legend on a white background unless otherwise specified.
- Sign message of Cardinal Direction Marker (M6-1) shall be denoted by the following suffixes:
M6-1-N : NORTH
M6-1-E : EAST
M6-1-S : SOUTH
M6-1-W : WEST
- Auxiliary markers denoted with the suffix "I" (M4-1-I) shall have a white legend on a blue background.
- Cardinal Direction Marker (M6-1) with suffix I(3) shall have a white legend on a blue background and shall be 30" x 15" in size.
- For MI-3 and MI-4 signs, number in () indicates route number and shall be as shown on the plan.

STATE OF HAWAII
DEPARTMENT OF TRANSPORTATION
HIGHWAYS DIVISION
STANDARD DETAILS
STATE ROUTE MARKERS
AND
AUXILIARY MARKERS
Scale: As Noted
SHEET NO. 5 OF 5 SHEETS

22