

FED. ROAD DIST. NO.	STATE	FED. AID PROJ. NO.	FISCAL YEAR	SHEET NO.	TOTAL SHEETS
HAWAII	HAW.	STP-0130(27)	2021	64	116

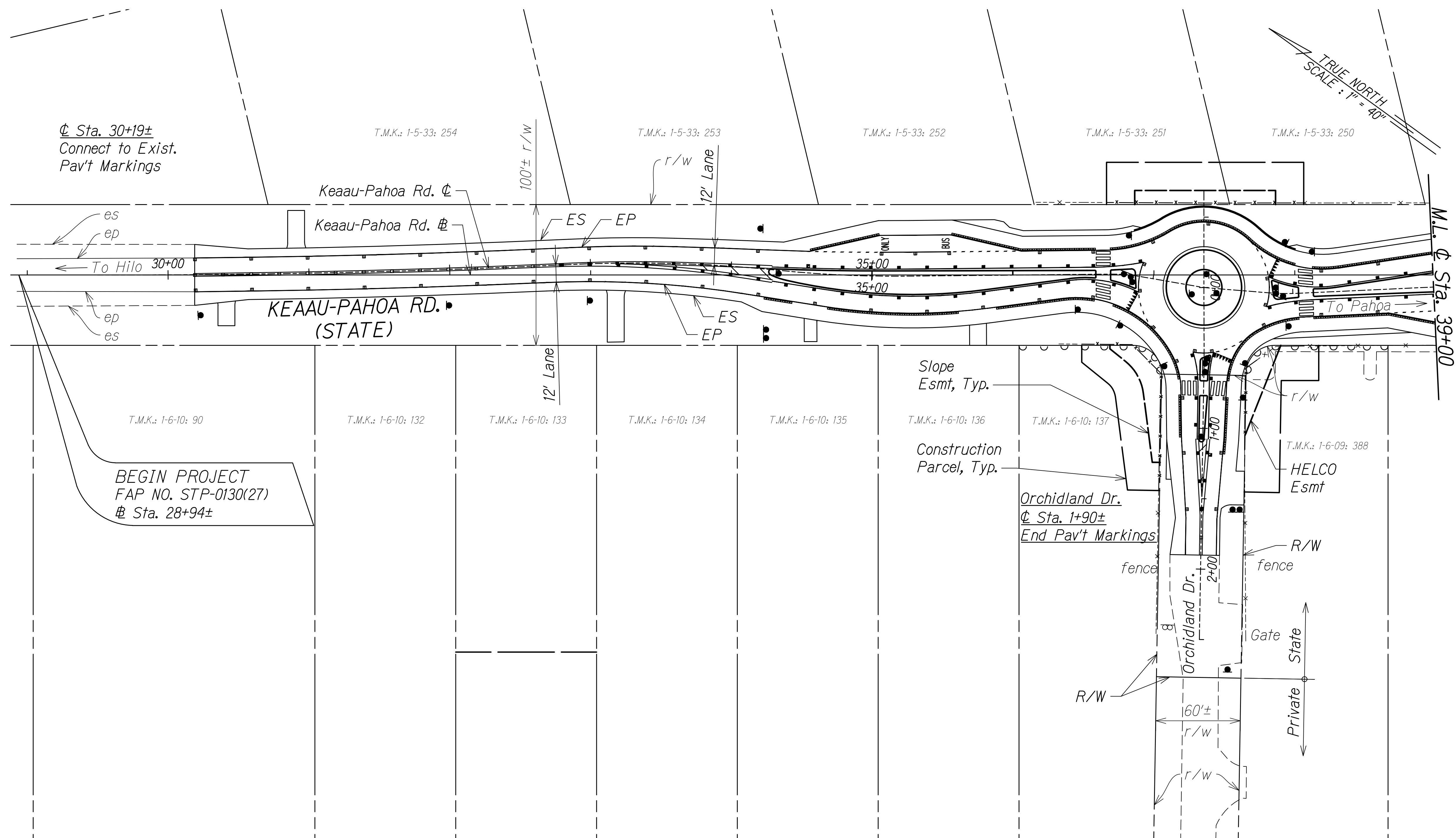

C:_CIVIL_3D_PROJECTS\2012_153,000_KEAAU-PAHOA_RD_IMPR_RTE130\ROUNDABOUT DESIGN\01 CIVIL DRAWINGS\02 ORCH AND MAKUU\064 - 065 PAVT MARK AND SIGN PLANS - ORCHLAND.DWG 8/25/2020 7:38 PM KSAW

☐ Sta. 30+19±
Connect to Exist.
Pav't Markings

To Hilo 30+00

KEAAU-PAHOA RD.
(STATE)

BEGIN PROJECT
FAP NO. STP-0130(27)
☐ Sta. 28+94±

Orchidland Dr.
☐ Sta. 1+90±
End Pav't Markings

M.L.
☐ Sta. 39+00

TRUE NORTH
SCALE: 1" = 40'

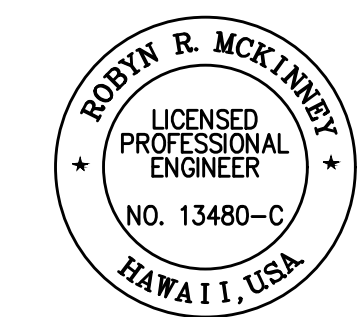
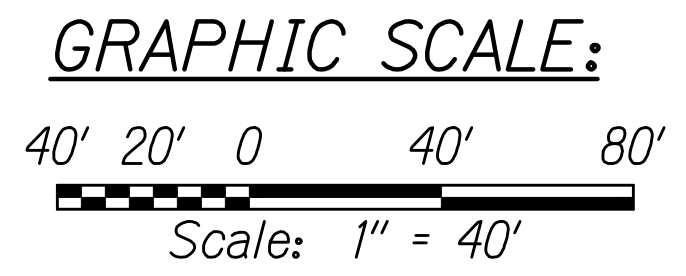

THIS WORK WAS PREPARED BY ME
OR UNDER MY SUPERVISION AND
CONSTRUCTION OF THIS PROJECT
WILL BE UNDER MY OBSERVATION.

Robyn McKinney 04/30/22
SIGNATURE EXPIRATION DATE
OF THE LICENSE

STATE OF HAWAII
DEPARTMENT OF TRANSPORTATION
HIGHWAYS DIVISION

**OVERALL PAVEMENT
MARKING AND SIGNING PLAN**

KEAAU-PAHOA ROAD
INTERSECTION IMPROVEMENTS
at Orchidland Drive & Makuu Drive
Federal-Aid Project No. STP-0130(27)

Scale: 1" = 40' Date: Sept, 2020

SHEET No. 1 OF 13 SHEETS

FED. ROAD DIST. NO.	STATE	FED. AID PROJ. NO.	FISCAL YEAR	SHEET NO.	TOTAL SHEETS
HAWAII	HAW.	STP-0130(27)	2021	65	116

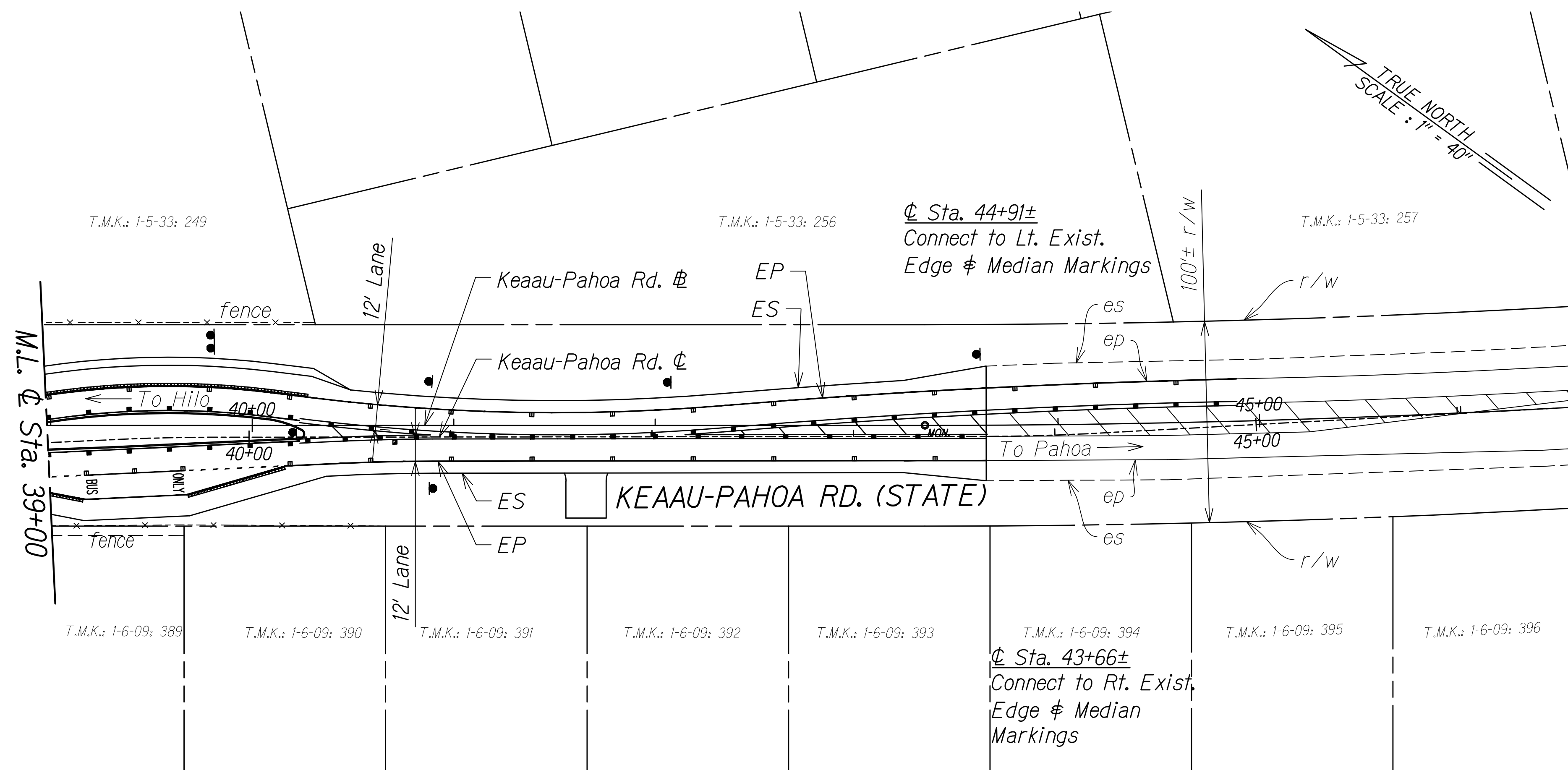

C:_CIVIL_3D_PROJECTS\2012_153,000_KEAAU-PAHOA_RD_IMPR_RTE130\ROUNDABOUT DESIGN\01 CIVIL DRAWINGS\02 ORCH AND MAKUU\064 - 065 PAVT MARK AND SIGN PLANS - ORCHLAND.DWG 8/25/2020 7:36 PM KSAW

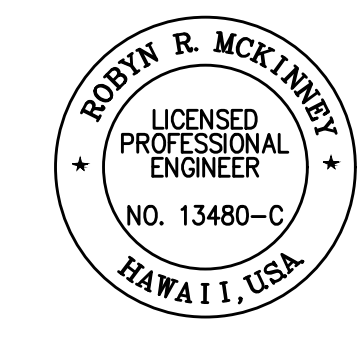
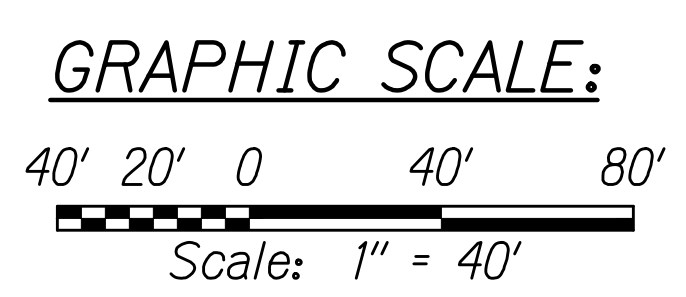

THIS WORK WAS PREPARED BY ME OR UNDER MY SUPERVISION AND CONSTRUCTION OF THIS PROJECT WILL BE UNDER MY OBSERVATION.

Roryn McKinney 04/30/22
SIGNATURE EXPIRATION DATE OF THE LICENSE

STATE OF HAWAII
DEPARTMENT OF TRANSPORTATION
HIGHWAYS DIVISION

OVERALL PAVEMENT MARKING AND SIGNING PLAN

KEAAU-PAHOA ROAD
INTERSECTION IMPROVEMENTS
at Orchidland Drive & Makuu Drive
Federal-Aid Project No. STP-0130(27)

Scale: 1" = 40' Date: Sept, 2020

SHEET No. 2 OF 13 SHEETS

FED. ROAD DIST. NO.	STATE	FED-AID PROJ. NO.	FISCAL YEAR	SHEET NO.	TOTAL SHEETS
HAWAII	HAW.	STP-0130(27)	2021	66	116

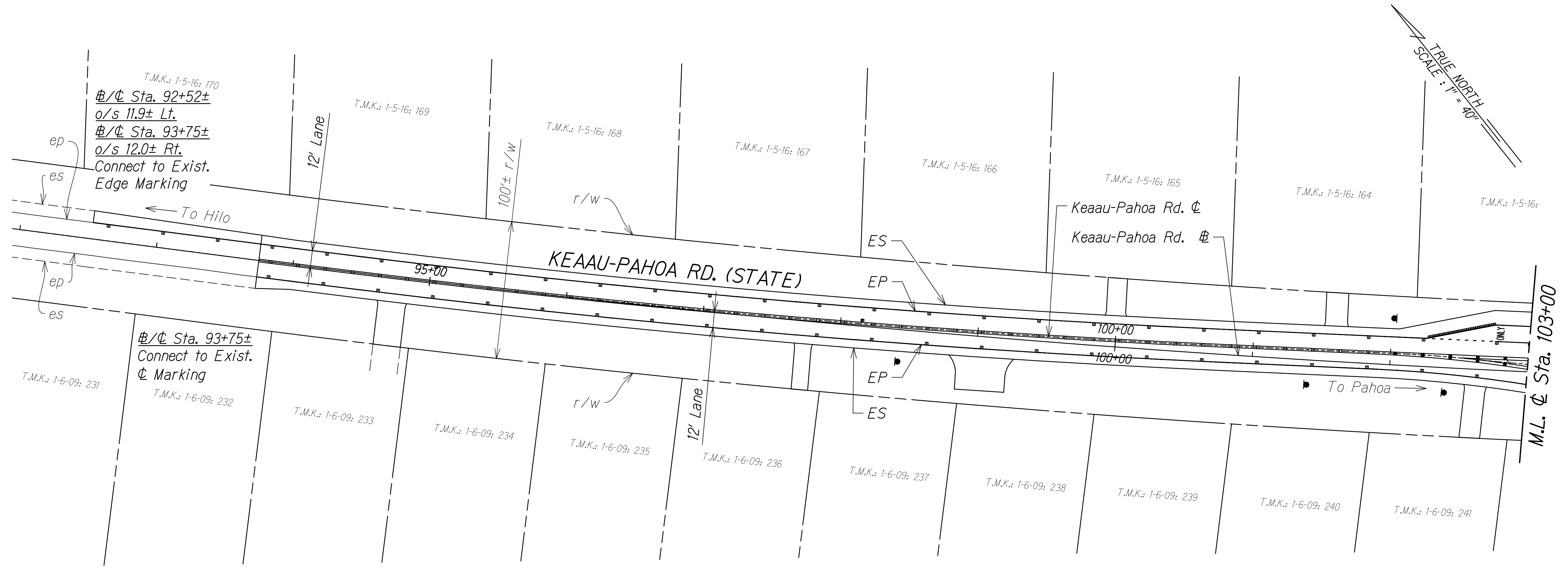

TRUE NORTH
SCALE: 1" = 40'

C:\CIVIL_3D_PROJECTS\2012_153,000_KEAAU-PAHOA_RD_IMPR_RTE130\ROUNDABOUT DESIGN\01 CIVIL DRAWINGS\02 ORCH AND MAKUU\066 - 067 PAVT MARK AND SIGN PLANS - MAKUU.DWG 8/25/2020 7:34 PM KSAW

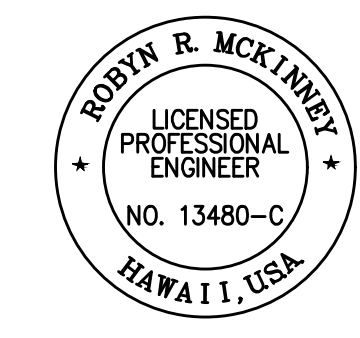
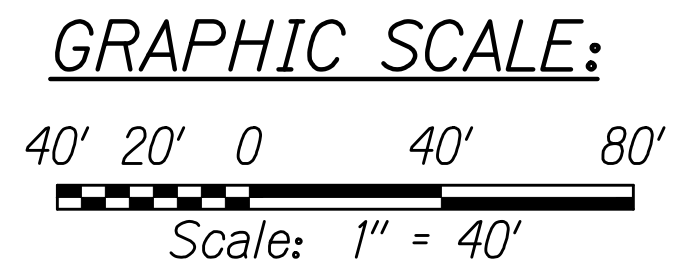

THIS WORK WAS PREPARED BY ME OR UNDER MY SUPERVISION AND CONSTRUCTION OF THIS PROJECT WILL BE UNDER MY OBSERVATION.
Robyn McKinney 04/30/22
SIGNATURE EXPIRATION DATE OF THE LICENSE

STATE OF HAWAII
DEPARTMENT OF TRANSPORTATION
HIGHWAYS DIVISION

OVERALL PAVEMENT MARKING AND SIGNING PLAN

KEAAU-PAHOA ROAD
INTERSECTION IMPROVEMENTS
at Orchidland Drive & Makuu Drive
Federal-Aid Project No. STP-0130(27)

Scale: 1" = 40' Date: Sept, 2020

SHEET No. 3 OF 13 SHEETS

FED. ROAD DIST. NO.	STATE	FED. AID PROJ. NO.	FISCAL YEAR	SHEET NO.	TOTAL SHEETS
HAWAII	HAW.	STP-0130(27)	2021	67	116

C:_CIVIL_3D_PROJECTS\2012_153,000_KEAAU-PAHOA_RD_IMPR_RTE130\ROUNDABOUT DESIGN\01 CIVIL DRAWINGS\02 ORCH AND MAKUU\066 - 067 PAVT MARK AND SIGN PLANS - MAKUU.DWG 8/28/2020 1:53 PM SRODELAS

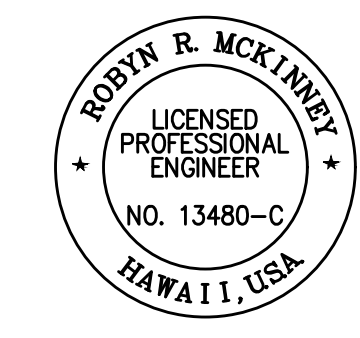
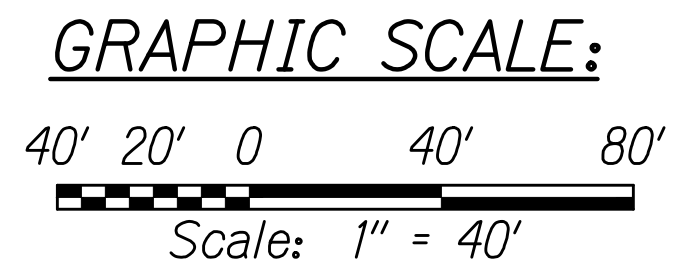
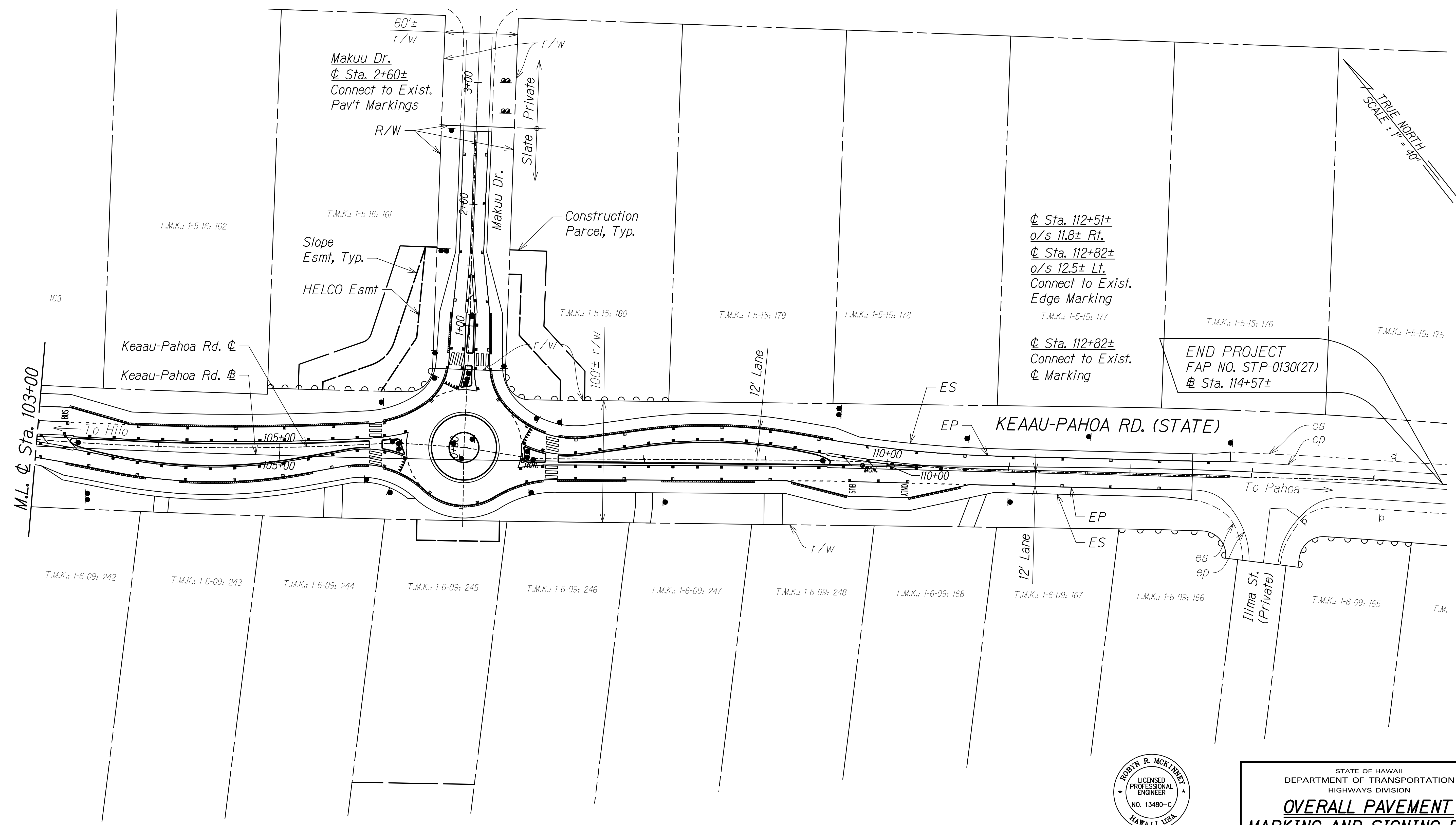

THIS WORK WAS PREPARED BY ME OR UNDER MY SUPERVISION AND CONSTRUCTION OF THIS PROJECT WILL BE UNDER MY OBSERVATION.

Rodyn McKinney 04/30/22
 SIGNATURE EXPIRATION DATE OF THE LICENSE

STATE OF HAWAII
 DEPARTMENT OF TRANSPORTATION
 HIGHWAYS DIVISION

OVERALL PAVEMENT MARKING AND SIGNING PLAN

KEAAU-PAHOA ROAD
 INTERSECTION IMPROVEMENTS
 at Orchidland Drive & Makuu Drive
 Federal-Aid Project No. STP-0130(27)

Scale: 1" = 40' Date: Sept, 2020

SHEET No. 4 OF 13 SHEETS

FED. ROAD DIST. NO.	STATE	FED-AID PROJ. NO.	FISCAL YEAR	SHEET NO.	TOTAL SHEETS
HAWAII	HAW.	STP-0130(27)	2021	68	116

C:_CIVIL_3D_PROJECTS\2012_153.000_KEAAU-PAHOA_RD_IMPR_RTE130\ROUNDABOUT DESIGN\01_CIVIL DRAWINGS\02_ORCH AND MAKUU\068 - 070_PAVT MARK SIGN PLANS_20_ORCHIDLAND.DWG - 8/26/2020 10:46 AM KSAW

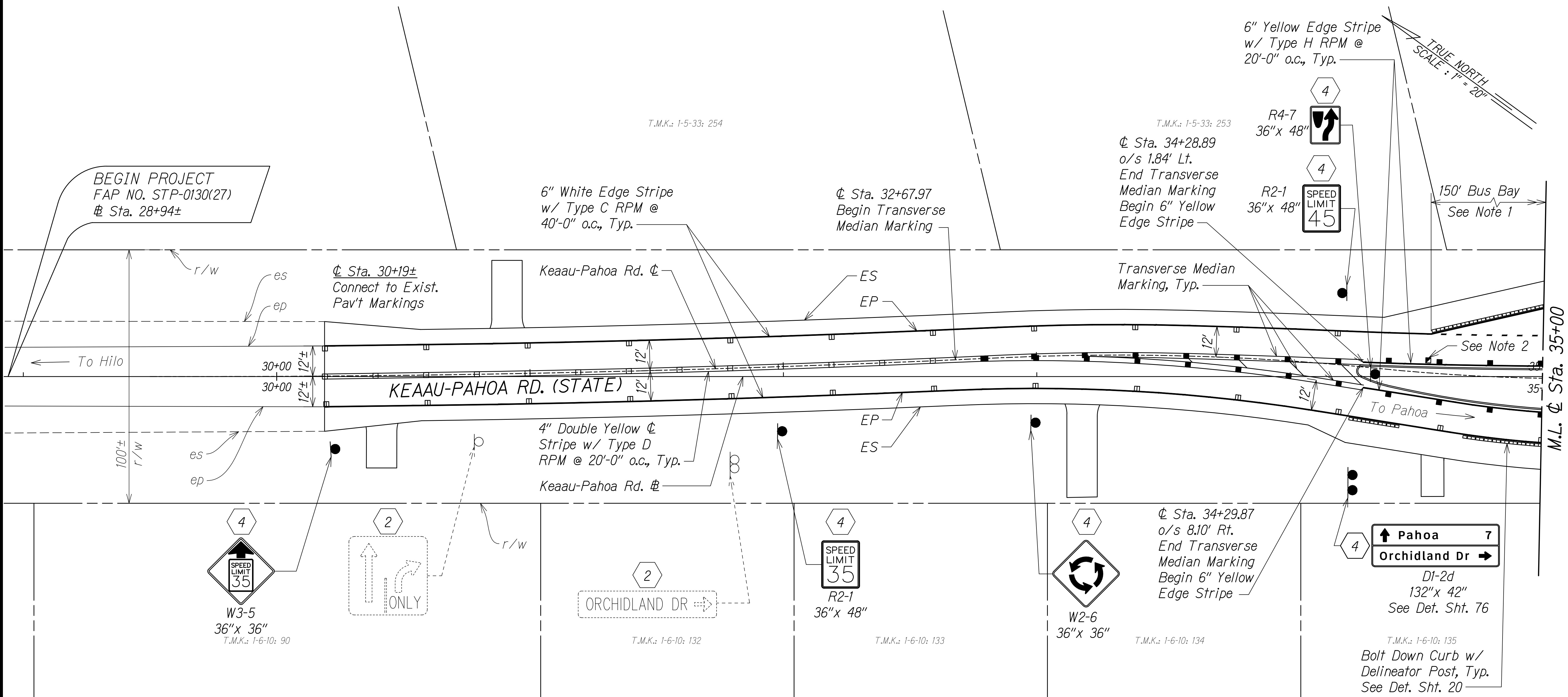

SIGNING KEY:

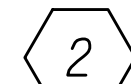
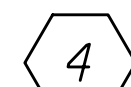
-  Remove Exist. Sign(s) w/ Post(s)
-  Install New Sign(s) w/ Post(s)

NOTES:

1. For typical bus bay pavement markings, see Sht. 63.
2. For fire hydrant marker location, see DWS Std. Det. FH13.

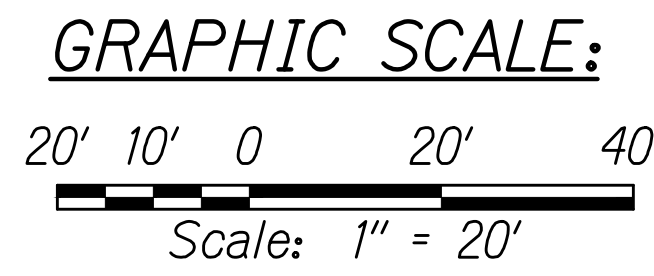

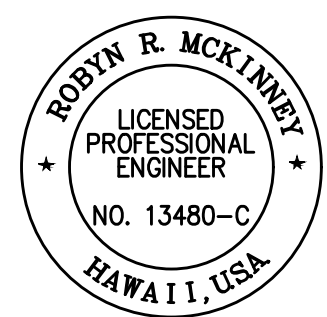

THIS WORK WAS PREPARED BY ME OR UNDER MY SUPERVISION AND CONSTRUCTION OF THIS PROJECT WILL BE UNDER MY OBSERVATION.

Robyn McKinney 04/30/22
SIGNATURE EXPIRATION DATE OF THE LICENSE

STATE OF HAWAII
DEPARTMENT OF TRANSPORTATION
HIGHWAYS DIVISION

PAVEMENT MARKING AND SIGNING PLAN

KEAAU-PAHOA ROAD
INTERSECTION IMPROVEMENTS
at Orchidland Drive & Makuu Drive
Federal-Aid Project No. STP-0130(27)

Scale: 1" = 20' Date: Sept, 2020

SHEET No. 5 OF 13 SHEETS

FED. ROAD DIST. NO.	STATE	FED. AID PROJ. NO.	FISCAL YEAR	SHEET NO.	TOTAL SHEETS
HAWAII	HAW.	STP-0130(27)	2021	69	116

NOTES:

1. For typical bus bay pavement markings, see Sht. 63.
2. For crosswalk marking dimensions, see Sht. 63.
3. The minimum required vertical clearance for signs within potential pedestrian path such as shoulders and crosswalks is 7 feet.
4. For fire hydrant marker location, see DWS Std. Det. FH13.
5. For curve, and point data, see Sht. 70.

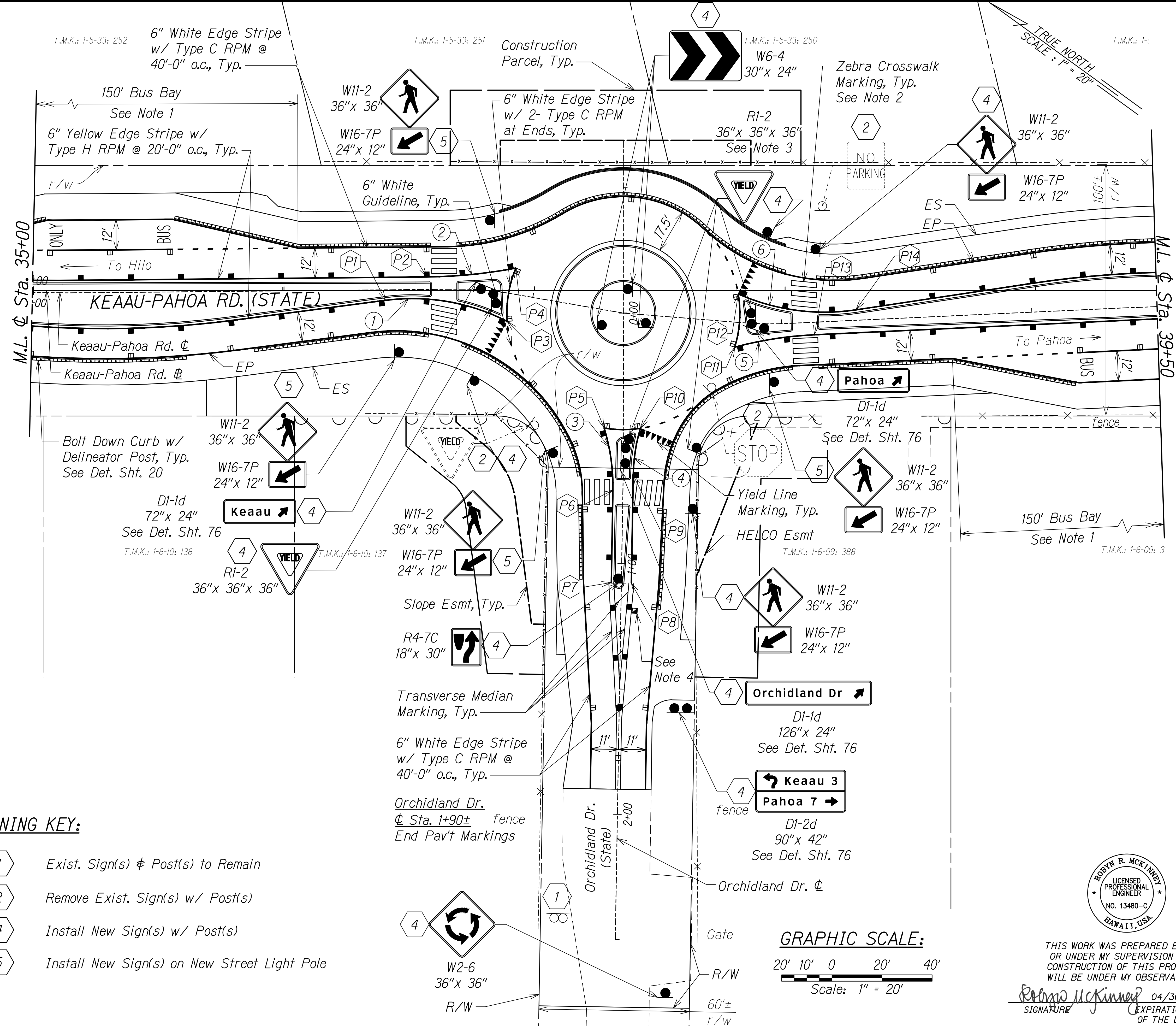

SIGNING KEY:

- 1 Exist. Sign(s) & Post(s) to Remain
- 2 Remove Exist. Sign(s) w/ Post(s)
- 4 Install New Sign(s) w/ Post(s)
- 5 Install New Sign(s) on New Street Light Pole

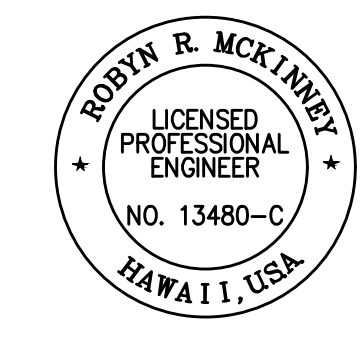
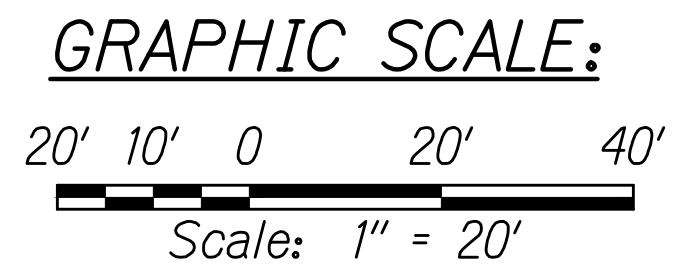

THIS WORK WAS PREPARED BY ME OR UNDER MY SUPERVISION AND CONSTRUCTION OF THIS PROJECT WILL BE UNDER MY OBSERVATION.

Rodyn McKinney 04/30/22
 SIGNATURE EXPIRATION DATE OF THE LICENSE

STATE OF HAWAII
 DEPARTMENT OF TRANSPORTATION
 HIGHWAYS DIVISION

PAVEMENT MARKING AND SIGNING PLAN

KEAAU-PAHOA ROAD
 INTERSECTION IMPROVEMENTS
 at Orchidland Drive & Makuu Drive
 Federal-Aid Project No. STP-0130(27)

Scale: 1" = 20' Date: Sept, 2020

SHEET No. 6 OF 13 SHEETS

FED. ROAD DIST. NO.	STATE	FED. AID PROJ. NO.	FISCAL YEAR	SHEET NO.	TOTAL SHEETS
HAWAII	HAW.	STP-0130(27)	2021	70	116

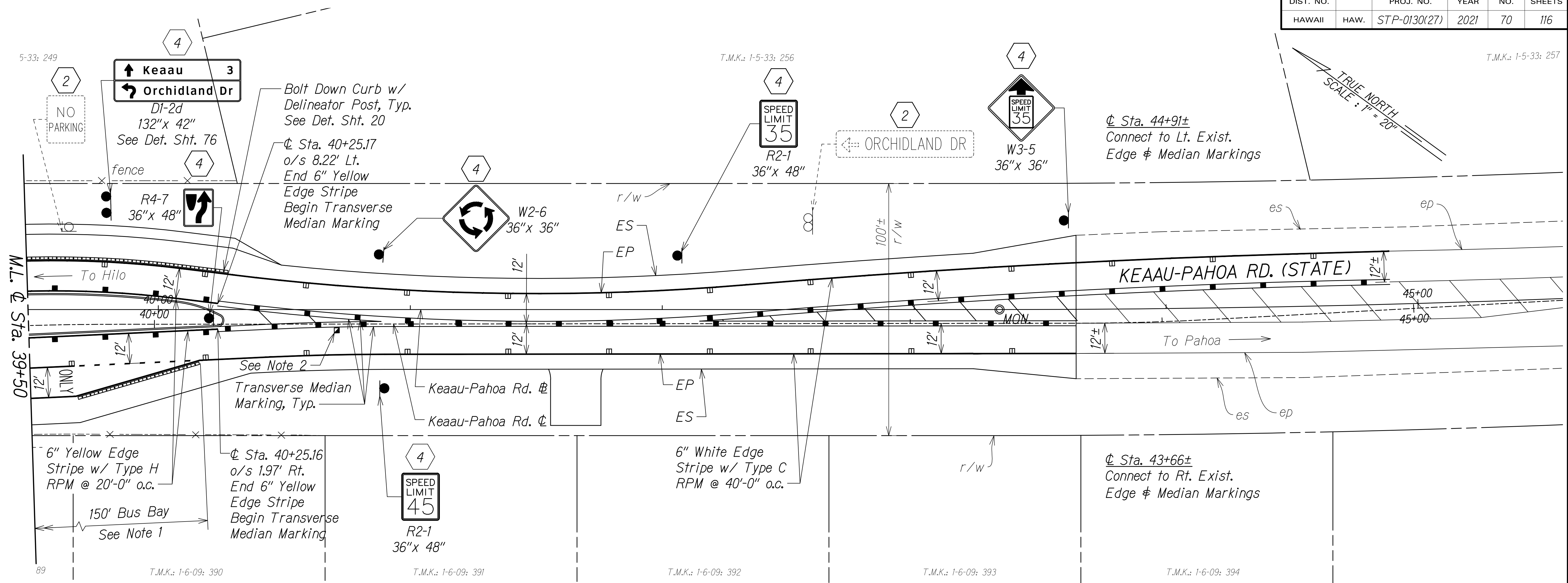

POINT DATA:

- | | | | | | |
|-----|---|-----|---|-----|--|
| P1 | ☉ Sta. 36+40.89
o/s 4.17' Rt.
PC Stripe | P2 | ☉ Sta. 36+57.51
o/s 5.00' Lt.
PT Stripe | P3 | ☉ Sta. 36+91.53
o/s 11.17' Rt.
PT Stripe |
| P4 | ☉ Sta. 36+91.34
o/s 10.38' Lt.
PC Stripe | P5 | Orchidland Dr.
☉ Sta. 0+45.84
o/s 7.80' Rt.
PC Stripe | P6 | Orchidland Dr.
☉ Sta. 0+70.72
o/s 4.00' Rt.
PT Stripe |
| P7 | Orchidland Dr.
☉ Sta. 1+07.59
o/s 4.01' Rt.
End 6" Yellow
Edge Stripe
Begin Transverse
Median Marking | P8 | Orchidland Dr.
☉ Sta. 1+07.67
o/s 4.00' Lt.
End 6" Yellow
Edge Stripe
Begin Transverse
Median Marking | P9 | Orchidland Dr.
☉ Sta. 0+64.59
o/s 4.00' Lt.
PC Stripe |
| P10 | ☉ Sta. 37+47.17
o/s 45.30' Rt.
PT Stripe | P11 | ☉ Sta. 37+82.10
o/s 9.93' Rt.
PC Stripe | P12 | ☉ Sta. 37+81.78
o/s 11.30' Lt.
PT Stripe |
| P13 | ☉ Sta. 38+12.89
o/s 5.00' Rt.
PT Stripe | P14 | ☉ Sta. 38+29.91
o/s 4.18' Lt.
PC Stripe | | |

CURVE DATA:

CURVE	①	②	③	④	⑤	⑥
Δ	34°33'10.68"	10°14'51.10"	18°00'06.27"	15°29'38.11"	12°18'42.77"	32°22'27.94"
Δ/2	17°16'35.34"	5°07'25.55"	9°00'03.13"	7°44'49.06"	6°09'21.39"	16°11'13.97"
R	83.00'	200.00'	80.00'	70.00'	150.00'	85.00'
T	25.81'	17.93'	12.67'	9.52'	16.18'	24.67'
C	49.30'	35.72'	25.03'	18.87'	32.17'	47.39'
Lc	50.05'	35.77'	25.14'	18.93'	32.23'	48.03'

SIGNING KEY:

- ② Remove Exist. Sign(s) w/ Post(s)
- ④ Install New Sign(s) w/ Post(s)

NOTES:

1. For typical bus bay pavement markings, see Sht. 63.
2. For fire hydrant marker location, See DWS Std. Det. FH13.

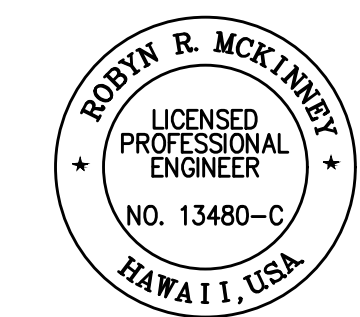
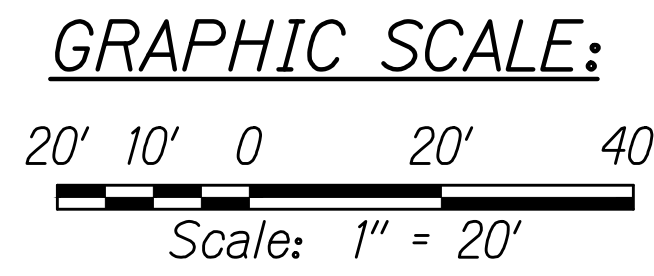

THIS WORK WAS PREPARED BY ME OR UNDER MY SUPERVISION AND CONSTRUCTION OF THIS PROJECT WILL BE UNDER MY OBSERVATION.

Rodyn McKinney 04/30/22
SIGNATURE (EXPIRATION DATE OF THE LICENSE)

STATE OF HAWAII
DEPARTMENT OF TRANSPORTATION
HIGHWAYS DIVISION

PAVEMENT MARKING AND SIGNING PLAN

KEAAU-PAHOA ROAD
INTERSECTION IMPROVEMENTS
at Orchidland Drive & Makuu Drive
Federal-Aid Project No. STP-0130(27)

Scale: 1" = 20' Date: Sept, 2020

SHEET No. 7 OF 13 SHEETS

FED. ROAD DIST. NO.	STATE	FED-AID PROJ. NO.	FISCAL YEAR	SHEET NO.	TOTAL SHEETS
HAWAII	HAW.	STP-0130(27)	2021	71	116

#/☉ Sta. 92+52±
 o/s 11.9± Lt.
 #/☉ Sta. 93+75±
 o/s 12.0± Rt.
 Connect to Exist.
 Edge Marking

#/☉ Sta. 93+75±
 Connect to Exist.
 ☉ Marking

4" Double Yellow ☉
 Stripe w/ Type D
 RPM @ 20'-0" o.c.

6" White Edge
 Stripe w/ Type C
 RPM @ 40'-0" o.c.

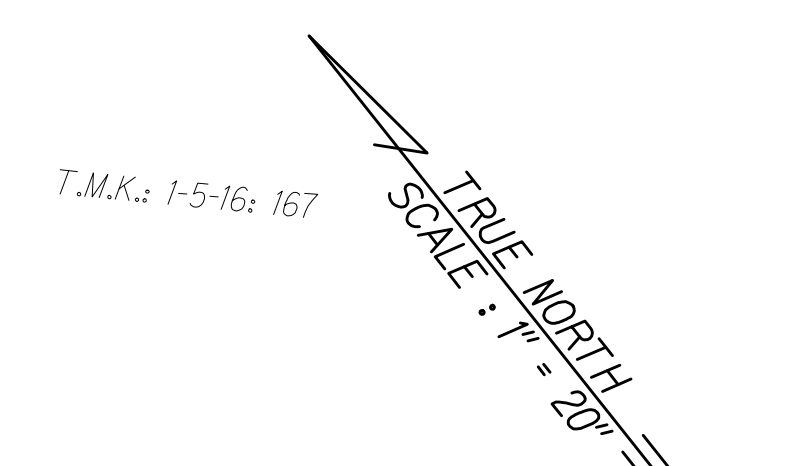
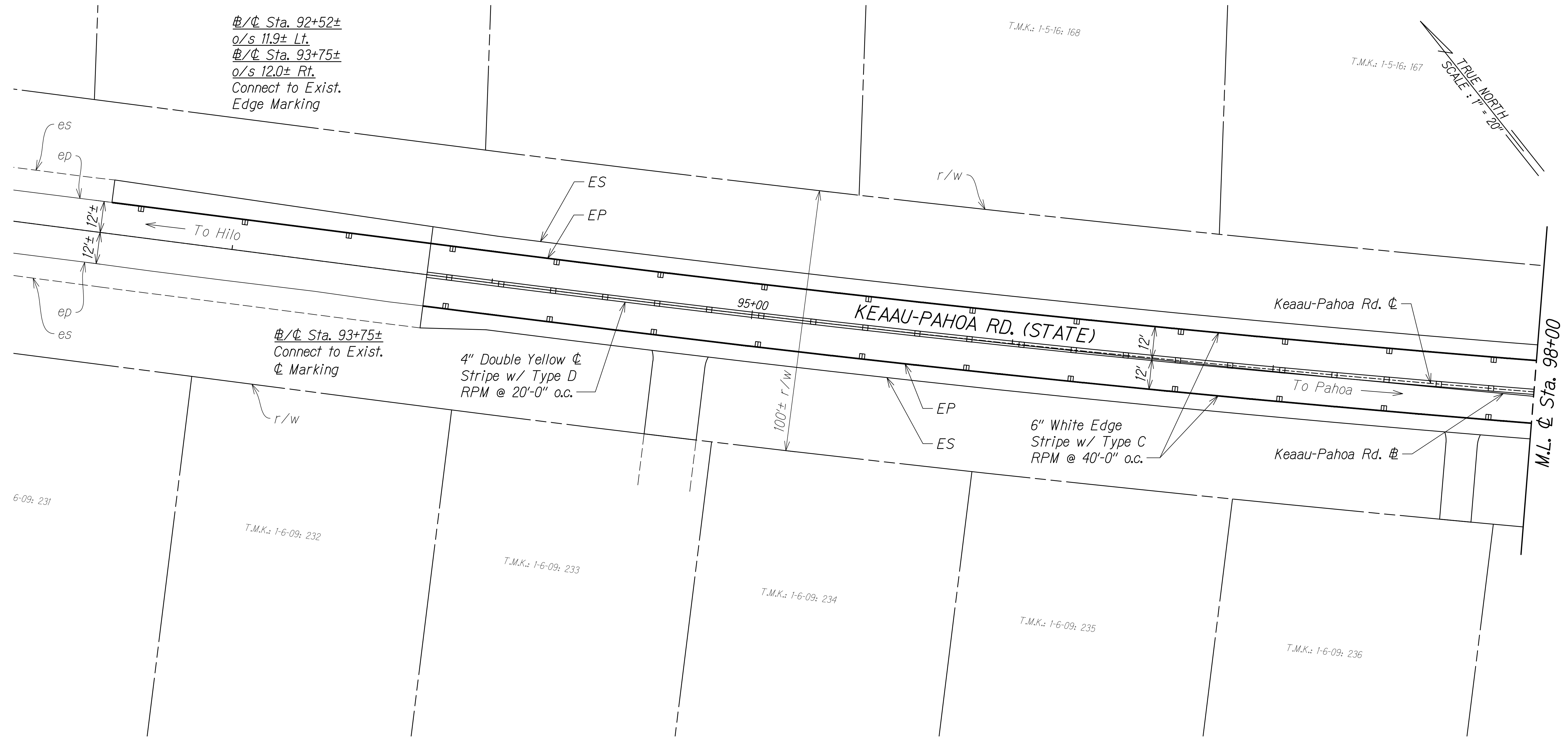

C:_CIVIL_3D_PROJECTS\2012_153.000_KEAAU-PAHOA_RD_IMPR_RTE130\ROUNDABOUT DESIGN\01 CIVIL DRAWINGS\02 ORCH AND MAKUU\071 - 074 PAVT MARK SIGN PLANS_20 MAKUU.DWG - 8/26/2020 11:29 AM KSAW

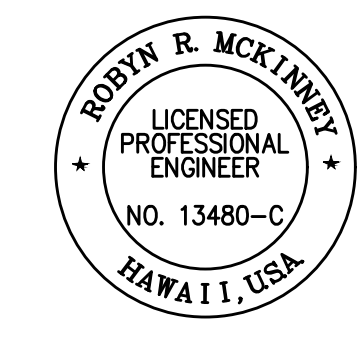
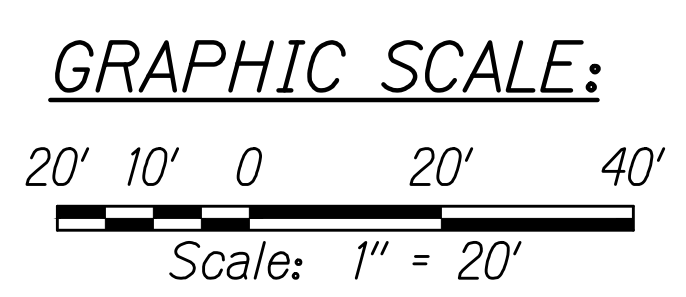

THIS WORK WAS PREPARED BY ME
 OR UNDER MY SUPERVISION AND
 CONSTRUCTION OF THIS PROJECT
 WILL BE UNDER MY OBSERVATION.

Robyn R. McKinney 04/30/22
 SIGNATURE EXPIRATION DATE
 OF THE LICENSE

STATE OF HAWAII
 DEPARTMENT OF TRANSPORTATION
 HIGHWAYS DIVISION

**PAVEMENT MARKING AND
 SIGNING PLAN**

KEAAU-PAHOA ROAD
 INTERSECTION IMPROVEMENTS
 at Orchidland Drive & Makuu Drive
 Federal-Aid Project No. STP-0130(27)

Scale: 1" = 20' Date: Sept, 2020

SHEET No. 8 OF 13 SHEETS

FED. ROAD DIST. NO.	STATE	FED-AID PROJ. NO.	FISCAL YEAR	SHEET NO.	TOTAL SHEETS
HAWAII	HAW.	STP-0130(27)	2021	72	116

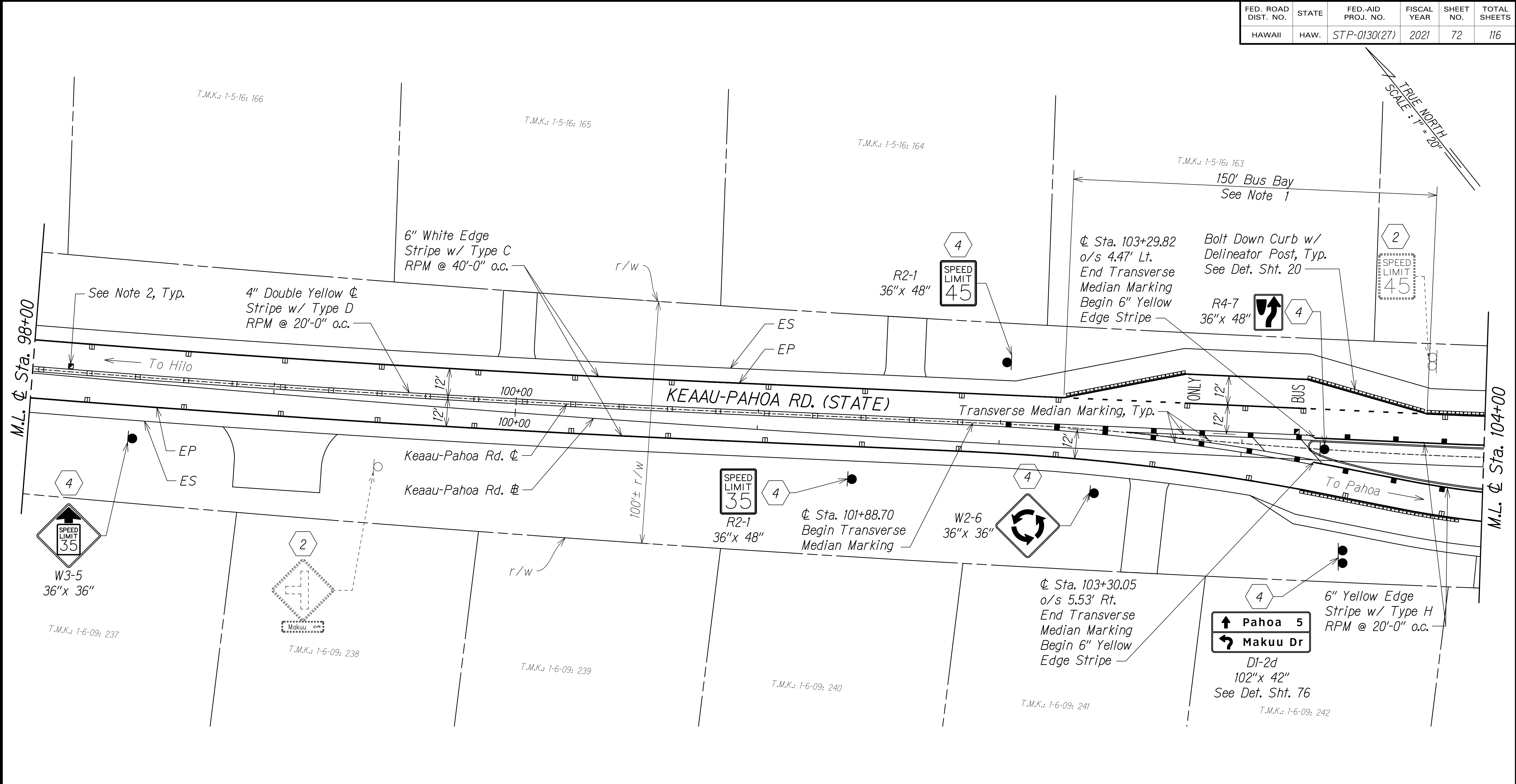

SIGNING KEY:

- Remove Exist. Sign(s) w/ Post(s)
- Install New Sign(s) w/ Post(s)

NOTES:

1. For typical bus bay pavement markings, see Sht. 63.
2. For fire hydrant marker location, see DWS Std. Det. FH13.

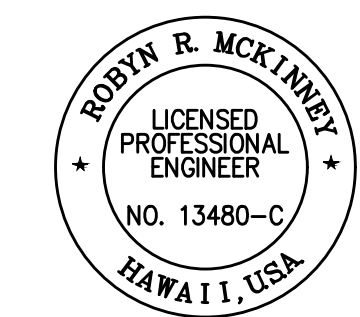
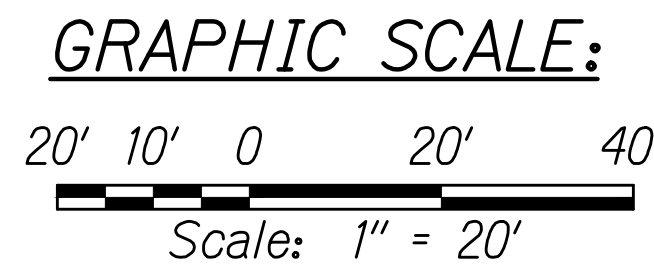

THIS WORK WAS PREPARED BY ME OR UNDER MY SUPERVISION AND CONSTRUCTION OF THIS PROJECT WILL BE UNDER MY OBSERVATION.

Robyn McKinney 04/30/22
SIGNATURE EXPIRATION DATE OF THE LICENSE

STATE OF HAWAII
DEPARTMENT OF TRANSPORTATION
HIGHWAYS DIVISION

**PAVEMENT MARKING AND
SIGNING PLAN**

KEAAU-PAHOA ROAD
INTERSECTION IMPROVEMENTS
at Orchidland Drive & Makuu Drive
Federal-Aid Project No. STP-0130(27)

Scale: 1" = 20' Date: Sept, 2020

SHEET No. 9 OF 13 SHEETS

C:_CIVIL_3D_PROJECTS\2012_153,000_KEAAU-PAHOA_RD_IMPR_RTE130\ROUNDABOUT DESIGN\01 CIVIL DRAWINGS\02 ORCH AND MAKUU\DWG - 074 PAVT MARK SIGN PLANS_20 MAKUU.DWG - 8/26/2020 11:44 AM KSAW

FED. ROAD DIST. NO.	STATE	FED-AID PROJ. NO.	FISCAL YEAR	SHEET NO.	TOTAL SHEETS
HAWAII	HAW.	STP-0130(27)	2021	73	116

NOTES:

1. For crosswalk marking dimension, see Sht. 63.
2. The minimum required vertical clearance for signs within potential pedestrian paths such as shoulders and crosswalks is 7 feet.
3. For curve, and point data, see Sht. 74.
4. For destination sign details, see Sht. 76.

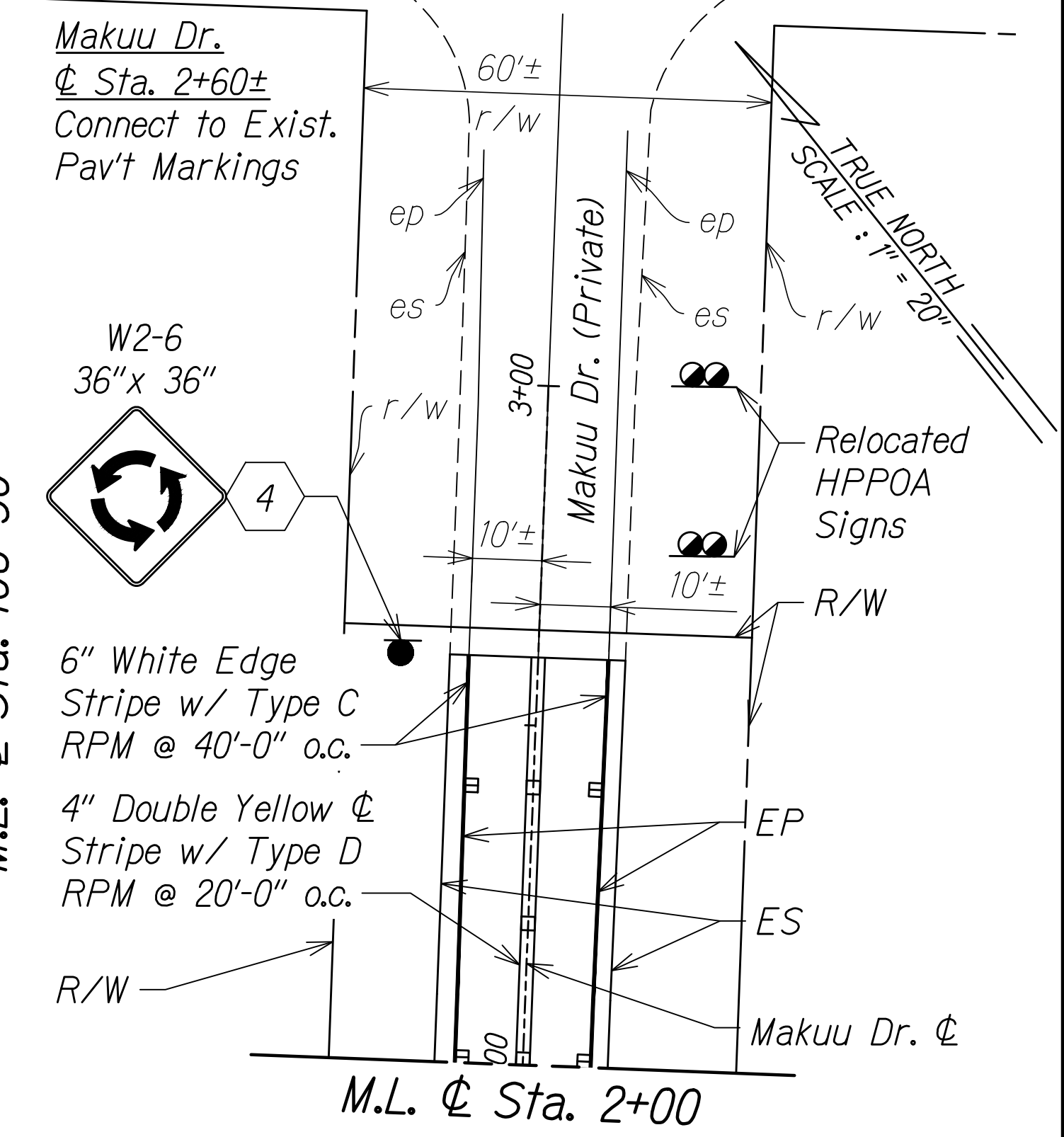
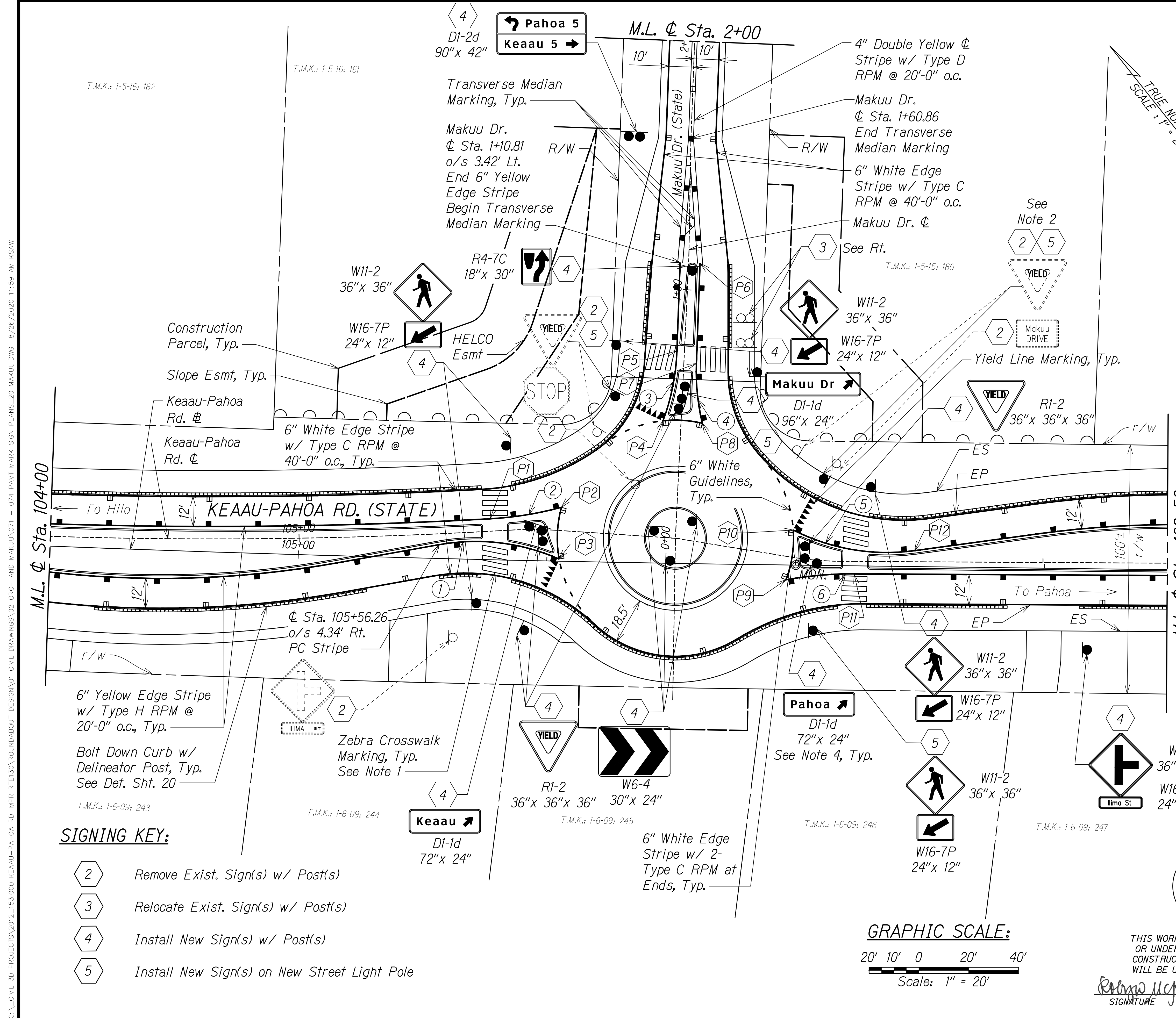

SIGNING KEY:

- ② Remove Exist. Sign(s) w/ Post(s)
- ③ Relocate Exist. Sign(s) w/ Post(s)
- ④ Install New Sign(s) w/ Post(s)
- ⑤ Install New Sign(s) on New Street Light Pole

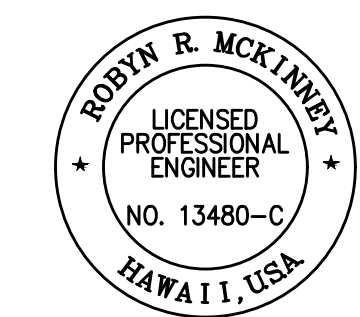
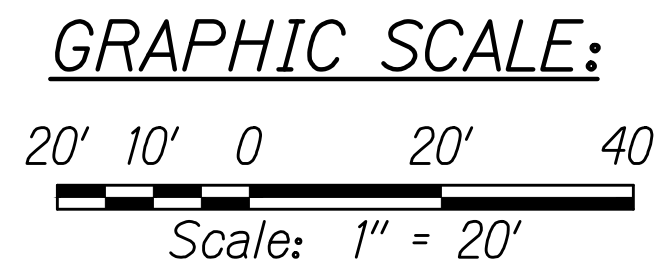

THIS WORK WAS PREPARED BY ME OR UNDER MY SUPERVISION AND CONSTRUCTION OF THIS PROJECT WILL BE UNDER MY OBSERVATION.

Robyn McKinney 04/30/22
 SIGNATURE EXPIRATION DATE OF THE LICENSE

STATE OF HAWAII
 DEPARTMENT OF TRANSPORTATION
 HIGHWAYS DIVISION

PAVEMENT MARKING AND SIGNING PLAN

KEAAU-PAHOA ROAD
 INTERSECTION IMPROVEMENTS
 at Orchidland Drive & Makuu Drive
 Federal-Aid Project No. STP-0130(27)

Scale: 1" = 20' Date: Sept, 2020

SHEET No. 10 OF 13 SHEETS

C:_CIVIL_3D_PROJECTS\2021_153,000_KEAAU-PAHOA_RD_IMPR_RTE130\ROUNDABOUT DESIGN\01_CIVIL DRAWINGS\02_ORCH AND MAKUU\DWG - 074_PAVT MARK SIGN PLANS_20 MAKUU.DWG - 8/26/2020 11:59 AM KSAW

FED. ROAD DIST. NO.	STATE	FED-AID PROJ. NO.	FISCAL YEAR	SHEET NO.	TOTAL SHEETS
HAWAII	HAW.	STP-0130(27)	2021	74	116

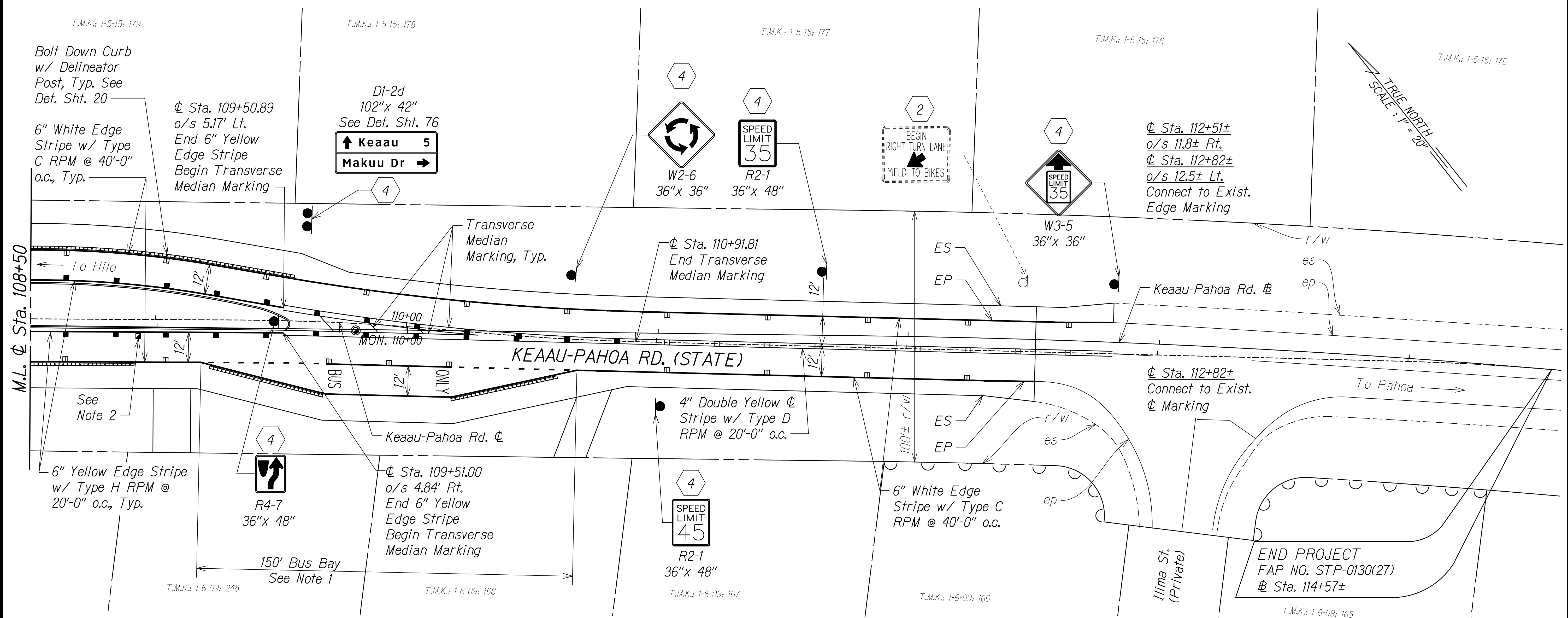

POINT DATA:

P1	☉ Sta. 105+77.13 o/s 5.00' Lt. PT Stripe	P2	☉ Sta. 106+04.94 o/s 9.35' Lt. PC Stripe	P3	☉ Sta. 106+05.42 o/s 11.47' Rt. PT Stripe	P4	☉ Sta. 106+43.40 o/s 46.80' Lt. PT Stripe
P5	Makuu Dr. ☉ Sta. 0+75.29 o/s 3.01' Lt. PC Stripe	P6	Makuu Dr. ☉ Sta. 1+10.91 o/s 4.58' Rt. End 6" Yellow Edge Stripe	P7	Makuu Dr. ☉ Sta. 0+70.56 o/s 5.05' Rt. PT Stripe	P8	☉ Sta. 106+54.72 o/s 47.39' Lt. PC Stripe
P9	☉ Sta. 106+98.09 o/s 9.32' Rt. PC Stripe		☉ Sta. 106+97.75 o/s 10.86' Lt. PT Stripe	P10	☉ Sta. 106+97.75 o/s 10.86' Lt. PT Stripe	P11	☉ Sta. 107+24.06 o/s 5.00' Rt. PT Stripe
P12	☉ Sta. 107+48.39 o/s 4.48' Lt. PC Stripe						

CURVE DATA:

CURVE	①	②	③	④	⑤	⑥
Δ	33°58'19.12"	11°54'47.16"	18°19'15.09"	15°23'05.13"	34°42'08.53"	10°29'52.05"
Δ/2	16°59'09.56"	5°57'23.58"	9°09'37.55"	7°41'32.56"	17°21'04.26"	5°14'56.03"
R	83.00'	140.00'	90.00'	90.00'	83.00'	150.00'
T	25.35'	14.61'	14.51'	12.16'	25.93'	13.78'
C	48.49'	29.06'	28.66'	24.09'	49.51'	27.44'
Lc	49.21'	29.11'	28.78'	24.17'	50.27'	27.48'

SIGNING KEY:

- ② Remove Exist. Sign(s) w/ Post(s)
- ④ Install New Sign(s) w/ Post(s)

GRAPHIC SCALE:

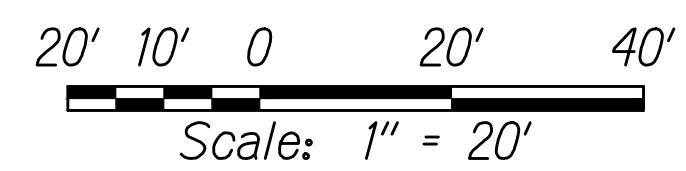

NOTES:

1. For typical bus bay pavement markings, see Sht. 63.
2. For fire hydrant marker location, see DWS Std. Det. FH13.

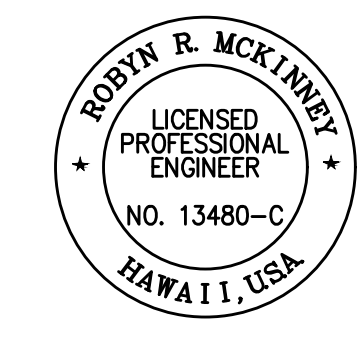

THIS WORK WAS PREPARED BY ME OR UNDER MY SUPERVISION AND CONSTRUCTION OF THIS PROJECT WILL BE UNDER MY OBSERVATION.
 SIGNATURE: *Rodney R. McKinney* 04/30/22
 EXPIRATION DATE OF THE LICENSE

STATE OF HAWAII
 DEPARTMENT OF TRANSPORTATION
 HIGHWAYS DIVISION

PAVEMENT MARKING AND SIGNING PLAN

KEAAU-PAHOA ROAD
 INTERSECTION IMPROVEMENTS
 at Orchidland Drive & Makuu Drive
 Federal-Aid Project No. STP-0130(27)

Scale: 1" = 20' Date: Sept, 2020

SHEET No. 11 OF 13 SHEETS

C:_CIVIL_3D_PROJECTS\2012_153.000_KEAAU-PAHOA_RD_IMPR_RTE130\ROUNDABOUT DESIGN\01_CIVIL DRAWINGS\02_ORCH AND MAKUU\071 - 074_PAVT. MARK SIGN PLANS_20_MAKUU.DWG - 8/26/2020 12:08 PM KSAW

GENERAL NOTES:

- Design Specifications:
 - Design shall conform with the latest AASHTO Standard Specifications for the Structural Supports for Highway Signs, Luminaires & Traffic Signals and its interim supplements and modifications by the Highways Division, Department of Transportation State of Hawaii.
 - Latest HDOT Memorandum with subject title "Design Criteria for Bridges and Structures."
- Loads:
 - Basic Wind Speed: 105mph
 - Recurrence Interval of 10 years
- Materials:
 - Post shall conform to the Standard Specifications.
 - All connection bolts shall be AASHTO M164 bolts and anchor bolts shall be AASHTO M314-105 bolt.
 - Lap splice nuts and bolts shall be M180, with an ultimate tensile strength of 180ksi, minimum.
 - Aluminum members and surfaces in contact with structural steel shall be isolated with neoprene material as approved by the Engineer.
- General:
 - See General Notes on B-01, TE-01, and TE-03B for additional information.
 - All posts shall be 12 gage unless otherwise specified or shown on the plans.
 - Square tube posts shall be perforated with 7/16"Ø holes, 1" o.c., 4 sides, along entire length of post.
 - All accessories, fittings and stiffener details (as required) shall be submitted to the Engineer for approval 20 days prior to installation.
 - Alternate designs in accordance with the plans and specifications shall use the Service Load Design Method and shall be stamped by a Registered Structural Engineer of the State of Hawaii and submitted to the Engineer for approval.
 - All sign support posts shall be outside of the clear zone or shielded by an appropriate traffic barrier system. The traffic barrier system shall submitted to the Engineer for his approval.
 - The Contractor shall use templates while installing the anchor bolts. Anchor bolts shall be vertical.
 - Excavation and backfill shall be considered incidental to the cost of the sign foundation.

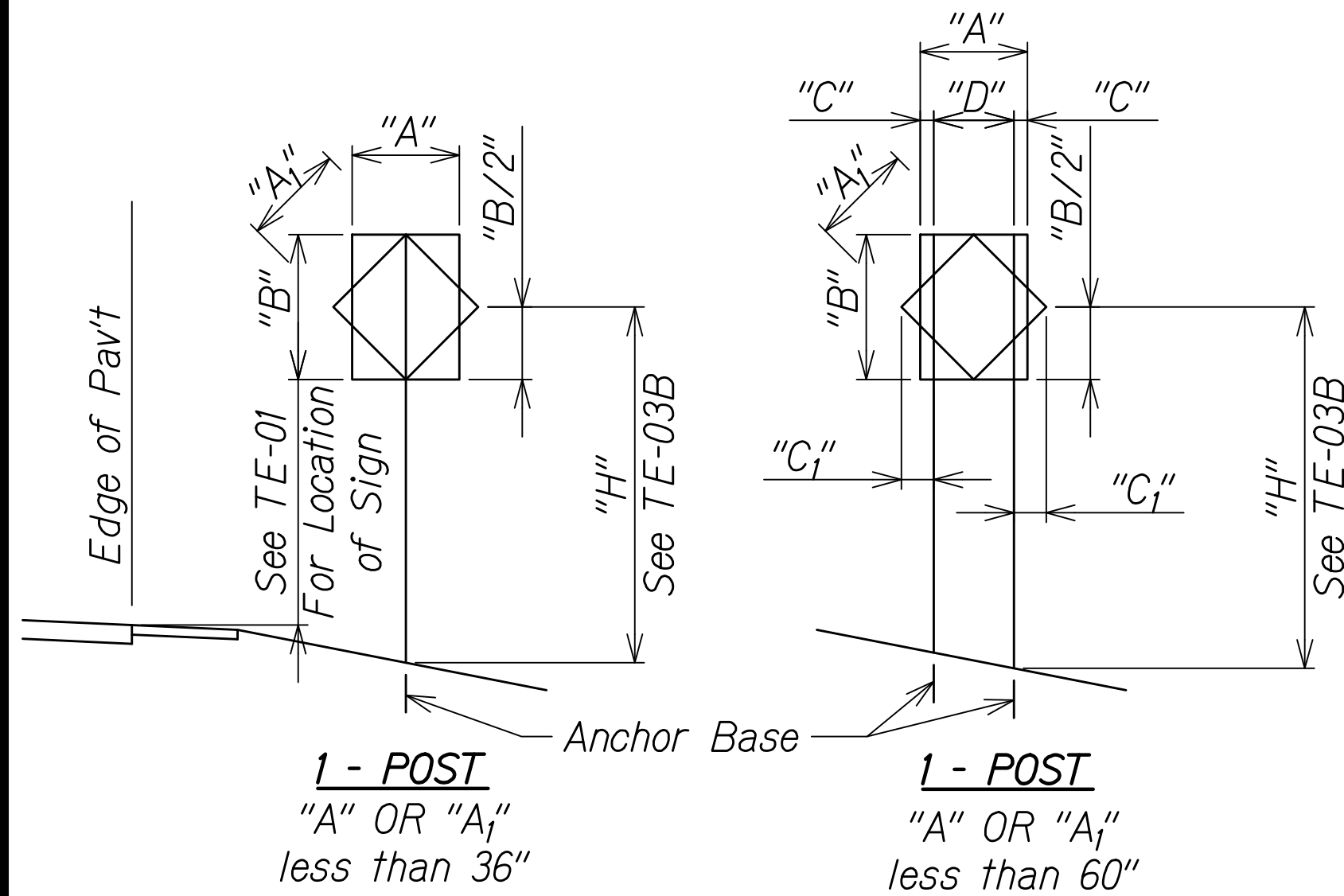

"A" or "A _i "	"C"	"C _i "
Less than 36"	6"	--
Greater than 36" & less than 48"	"g"	19"
Greater than 48"	12"	24"

NOTE:
Frame stiffeners are required when D is greater than 24", See General Notes.

TYPICAL INSTALLATION

Scale: NTS

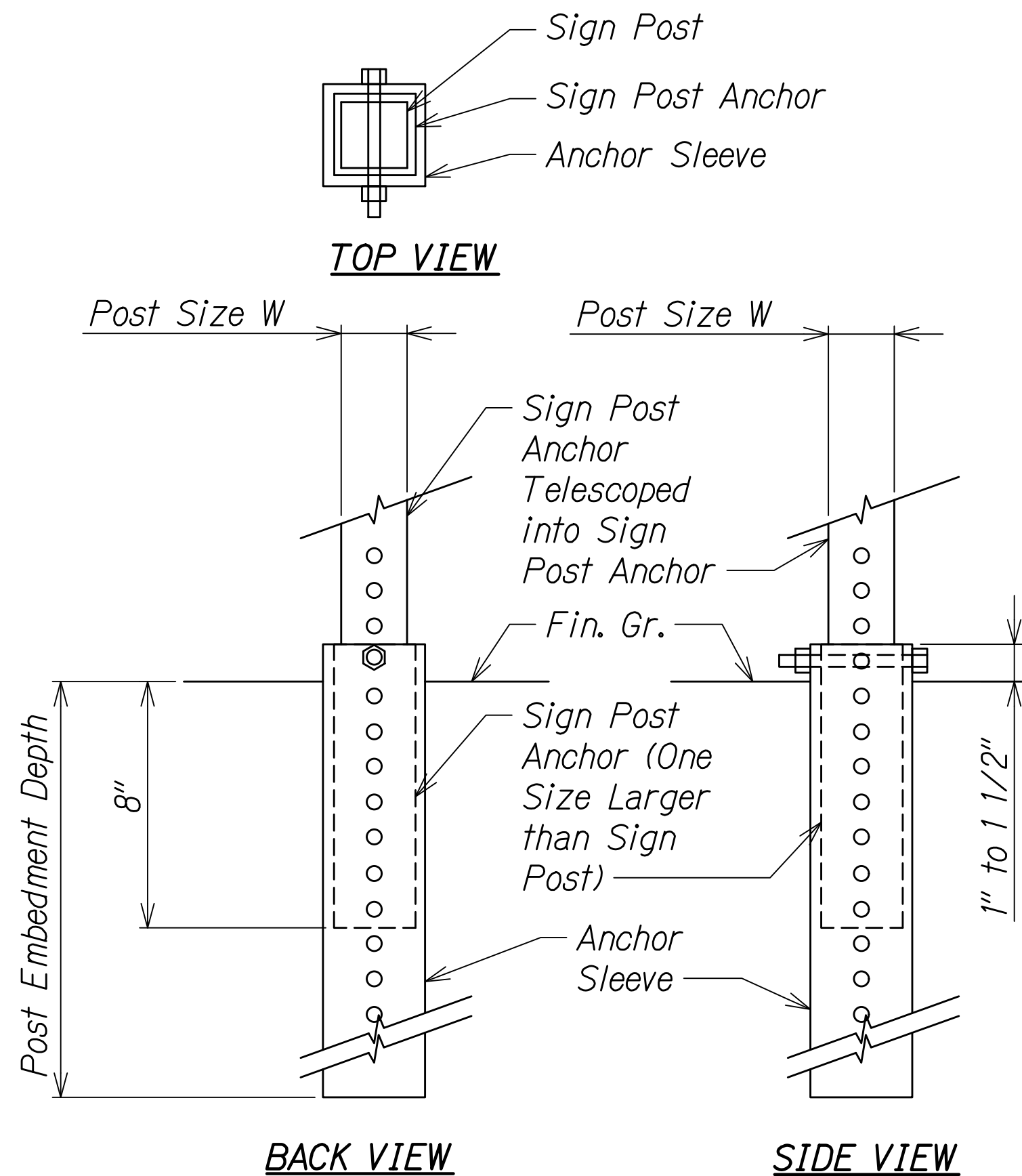

ANCHOR BASE DETAIL

Scale: NTS

C:_CIVIL_3D_PROJECTS\2012_153.000_KEAAU-PAHOA_RD_IMPR_RTE130\ROUNDABOUT DESIGN\01_CIVIL DRAWINGS\02_ORCH AND MAKUU\075_SIGN_POST_MOUNTING.DWG 8/25/2020 11:01 AM KSAW

STATE OF HAWAII
DEPARTMENT OF TRANSPORTATION
HIGHWAYS DIVISION

**GALVANIZED SQUARE TUBE
SIGN POST MOUNTING**

KEAAU-PAHOA ROAD
INTERSECTION IMPROVEMENTS
at Orchidland Drive & Makuu Drive
Federal-Aid Project No. STP-0130(27)

Scale: Not to Scale Date: Sept, 2020

SHEET No. 12 OF 13 SHEETS

